

# Complexity and Partitions

Dissertation zur Erlangung des  
naturwissenschaftlichen Doktorgrades  
der Bayerischen Julius-Maximilians-Universität Würzburg

vorgelegt von

Sven Kosub

aus

Rudolstadt

Würzburg, 2000

Eingereicht am: 29.11.2000

bei der Fakultät für Mathematik und Informatik

1. Gutachter: Prof. Dr. Klaus W. Wagner
2. Gutachter: Prof. Dr. Gerd Wechsung

Tag der mündlichen Prüfung: 18.05.2001

To Josef Knecht.



I am grateful to my thesis advisor Klaus W. Wagner for his continuous suggestions, and to Gerd Wechsung for refereeing my thesis. For many hints and discussions thanks are due to Lance Fortnow, Christian Glaßer, Lane A. Hemaspaandra, Steffen Reith, Heinz Schmitz, and Heribert Vollmer.



# Table of Contents

<b>List of Figures</b> .....	9
<b>1. Introduction</b> .....	11
<b>2. Preliminaries</b> .....	19
2.1 Mathematical Notions and Notations .....	19
2.1.1 Sets, Functions, and Words .....	19
2.1.2 Orders and Lattices .....	20
2.2 Complexity Classes and Hierarchies .....	22
2.2.1 NP and Its Relatives .....	23
2.2.2 The Polynomial Hierarchy .....	24
2.2.3 The Boolean Hierarchy .....	25
2.3 Partitions .....	27
<b>3. The Boolean Hierarchy of NP-Partitions</b> .....	29
3.1 Partition Classes Defined by Finite Functions .....	29
3.2 Partition Classes Defined by Lattices .....	32
3.3 Comparing Partition Classes .....	35
3.4 Minimal Descriptions of Partition Classes .....	37
3.5 The Embedding Conjecture .....	39
3.5.1 On Inverting the Embedding Lemma .....	39
3.5.2 Evidence I: The Case of $k$ -Chains .....	44
3.5.3 Evidence II: Beyond Chains .....	55
3.5.4 Next Steps Towards Resolution .....	60
3.6 On the Structure of $BH_3(NP)$ .....	60
3.7 Machines That Accept Partitions .....	64
<b>4. Refining the Boolean Hierarchy of NP-Partitions</b> .....	67
4.1 Partition Classes Defined by Posets .....	67
4.2 An Alternative Approach .....	71
4.3 Characterizing the Projective Closure .....	74
4.3.1 Projection Classes .....	74
4.3.2 Partition Classes Given in Free Representations .....	77
4.3.3 Partition Classes Given in Bound Representations .....	86
4.4 A Relativized Embedding Theorem .....	87
4.4.1 Refined Boolean Hierarchies and the Polynomial Hierarchy .....	88
4.4.2 Partition Classes and Leaf Languages .....	89

4.4.3 Relativizing Partition Classes .....	91
<b>5. Some Applications .....</b>	<b>95</b>
5.1 Separability within NP .....	95
5.1.1 Separability Notions .....	95
5.1.2 A Quantitative Approach to Separability .....	98
5.2 Fine Hierarchies inside $BH_2(NP)$ .....	102
5.3 Reducing the Set of Solutions of NP Problems .....	104
<b>Bibliography .....</b>	<b>109</b>
<b>Index .....</b>	<b>115</b>



# List of Figures

1.1	ENTAILMENT versus GRAPH EMBEDDING	16
2.1	The non-trivial levels of the boolean hierarchy over $\mathcal{K}$	26
3.1	Partition defined by a boolean 3-lattice	32
3.2	Partition defined by a 3-lattice	34
3.3	A 3-chain equivalent to the boolean 3-lattice in Figure 3.1	36
3.4	Non-isomorphic minimal equivalent boolean 3-lattices	38
3.5	The 3-lattices of Example 3.29	42
3.6	The 3-lattices critical for RE	43
3.7	Counterexample to the mind-change technique	45
3.8	The upper triangle	55
3.9	The lower triangle	58
3.10	A next step towards resolution of the Embedding Conjecture	60
3.11	Scheme of all boolean 3-lattices of the form $(\{1, 2\}^3, f)$ with $f(1, 1, 1) = 1$	61
3.12	Closer look at the middle part of the scheme in Figure 3.11	62
3.13	Closer look at the right part of the scheme in Figure 3.11	63
3.14	Classes with complete partitions having components of same complexities	66
4.1	The 4-poset for GRAPH EMBEDDING	69
4.2	The 2-poset $\mathfrak{D}_m$ for $m \in \mathbb{N}$	74
4.3	The 4-poset generating $(\mathcal{K}, \mathcal{K}(2), \mathcal{K}(2), \text{co}\mathcal{K})$	77
4.4	The 3-poset $\mathfrak{B}_{2s, 2t}$ for $s, t \in \mathbb{N}$	79
4.5	The 4-poset $\mathfrak{B}_{2, 2, 2}$	80
4.6	The 3-poset generating $(\text{co}\mathcal{K}(4), \text{co}\mathcal{K}(5), \cdot)$	86
4.7	The 3-poset generating $(\mathcal{K}(2), \mathcal{K}(2), \mathcal{K}(2))$	87
4.8	The 2-poset $\mathfrak{H}_m$ for $m \in \mathbb{N}_+$	88
4.9	The 3-posets critical for extending the Embedding Conjecture	89
5.1	The 4-posets $\mathfrak{S}_0$ (on the left) and $\mathfrak{S}_\infty$ (on the right)	97
5.2	The labeled posets $\mathfrak{S}_m$ (on the left) and $\mathfrak{S}_m^0$ (on the right) for $m \in \mathbb{N}$	98
5.3	A 3-separable pair of disjoint sets with its separating sets	99
5.4	The 2-poset $\mathfrak{F}(m, n)$	103
5.5	The 2-poset $\mathfrak{F}(m, \infty)$	103
5.6	The 2-poset $\mathfrak{F}(\infty, n)$	103
5.7	The 2-poset $\mathfrak{F}(\infty, \infty)$	103
5.8	The 2-posets generating classes between $(\text{NP} \cap \text{coNP}) \oplus \text{NP}$ and $\text{NP}(2) \cap \text{coNP}(2)$	104
5.9	The 5-posets $\mathfrak{N}(\{1, 3\})$ (on the left) and $\mathfrak{N}(\{1, 3\}, \{1, 2\})$ (on the right)	106



# 1. Introduction

To divide the real world into two parts like big and small, black and white, or good and bad usually oversimplifies things. In most cases a partition into many parts is more appropriate. For example, take marks in school, scores for papers submitted to a conference, salary groups, or classes of risk. In mathematics,  $k$ -valued logic is just a language for dealing with  $k$ -valent objects, and in the computer science field of artificial intelligence, this language has become a powerful tool for reasoning about incomplete knowledge. Belnap [Bel77] even argued that the way “a computer should think” should be based on four truth values. Nevertheless in computational complexity theory partitions have not been subjected to investigation.<sup>1</sup>

Complexity theoreticians study the amounts of resources algorithmic devices need to come up with solutions to given problem instances. Usually, the problems being considered are decision problems, i.e., sets or languages. Based on this restriction an elegant theory has grown up with a lot of fundamental notions and methods. In particular, the theory of reducibilities and NP-completeness is getting ahead in almost entire computer science and even beyond. The back of the medal, however, is that in order to apply this theory one often has to encode the problems artificially in decision problems. For instance, instead of computing the shortest tour a traveling salesperson may choose, it has to be asked whether there is a traveling salesperson tour shorter than some distance. Noticing that it is more reasonable to study functional problems in their original form as functions rather than in a decision shape has lead to an equally successful theory of complexity classes of functions.

Both extremes, investigating the complexity of sets, i.e., of partitions into two parts, or, on the other hand, investigating the complexity of functions, i.e., partitions into usually infinite parts, seem not appropriate for studying the computational complexity of problems inherently being partitions into finitely many parts. If we study partitions into at least three parts by means of set classes then we have to deal with projections onto certain components. But it is a basic mathematical truth that projections do not determine an object uniquely, or in other words, different objects can have the same projections. We may thus assume that many interesting phenomenons vanish when encoding partitions by sets. On the other side, though partitions can be considered as functions with finite range, even the finite range admits combinatorically arguing because each component depends only on the other finitely many components of the partition. We would lose this feature when simply subsuming the study of partitions under the study of functions.

This thesis is devoted to a systematic study of the computational complexity of partitions. Herein we will follow the approach to collect “similar” problems in complexity classes and to investigate relations among these classes. The approach is thus structural, i.e., we are inter-

---

<sup>1</sup> Except the implicit occurrences of partitions in the study of locally definable acceptance types [Her92a, Her92b] and the results in the diploma thesis [Juc96].

ested in the principles constituting class-membership of problems rather than the exploration of singular problems.

### Classification and Decision Problems for Relations

While complexity classes of sets represent decision problems our complexity classes of partitions represent, more generally, classification problems. Very important classes of classification problems originate from questions concerning relations.

Suppose that  $\sim_R$  is any binary relation on a basic set  $M$ . When giving an explicit definition of  $\sim_R$ , we specify  $\sim_R$  in the following way: For two elements  $x, y \in M$ ,  $x \sim_R y$  if and only if some definitional conditions hold for  $x$  and  $y$ . Thus the explicit specification of a relation has the form of a decision problem. But once the relation  $\sim_R$  is fixed, the more natural question is to determine for any given  $x$  and  $y$  how they behave with respect to  $\sim_R$ : Is it true that both  $x \sim_R y$  and  $y \sim_R x$  hold or only  $x \sim_R y$  holds or only  $y \sim_R x$  holds or is even nothing true? Questions of this kind are significant in connection with, e.g., entailment issues as studied in automated reasoning, database theory, and constraint programming, or congruence and isomorphism problems equally of broad interest.

For a concrete example let us consider the entailment relation  $\models$  for formulas of (two-valued) propositional logic. For propositional formulas  $H$  and  $H'$  it is defined as

$$H \models H' \iff_{\text{def}} \text{ each satisfying assignment for } H \text{ is a satisfying assignment for } H'.$$

Given two arbitrary formulas there are the above four possible cases to classify according to the behavior the formulas show with respect to  $\sim_R$ . We translate this into the partition ENTAILMENT. The most natural way to define a partition is to fix its characteristic function. For any partition  $A$  the characteristic function  $c_A$  says for every  $x$  to which component of  $A$  this  $x$  belongs. So for any pair  $(H, H')$  of formulas we define

$$c_{\text{ENTAILMENT}}(H, H') =_{\text{def}} \begin{cases} 1 & \text{if } H \not\models H' \text{ and } H' \not\models H, \\ 2 & \text{if } H \not\models H' \text{ and } H' \models H, \\ 3 & \text{if } H \models H' \text{ and } H' \not\models H, \\ 4 & \text{if } H \models H' \text{ and } H' \models H. \end{cases}$$

Some remarks to this definition: We should bring to mind that though the numbering of the cases to be distinguished is not essential for the classification itself yet it leads to different partitions. We also should be aware that for a collection of sets to be a partition it is not only necessary to have the pairwise disjointness of all sets but also that each element of a basic set must be contained in one of these sets. So to make the above definition precise we have to encode the pairs appropriately in order to put them into the four components. This is standard in complexity theory.

Apparently there exist very close connections between ENTAILMENT and the decision problem of whether  $H \models H'$  for given  $H$  and  $H'$ . Let us explain this in more detail. For we consider two sets  $A$  and  $B$  that describe the decision problem formally:  $A$  is the set of all pairs  $(H, H')$  such that  $H$  entails  $H'$  and  $B$  is the set of all pairs  $(H, H')$  such that  $H'$  entails  $H$ . The partition ENTAILMENT and the sets  $A$  and  $B$  are intimately related in at least the following two ways:

1. Using the sets  $A$  and  $B$  the partition **ENTAILMENT** can be easily rewritten. So the first component of **ENTAILMENT**, denoted by  $\text{ENTAILMENT}_1$ , consists of all pairs of propositional formulas that do not belong to  $A$  or  $B$ . Opposite to this the fourth component of **ENTAILMENT**, denoted by  $\text{ENTAILMENT}_4$ , is nothing else than  $A \cap B$ . Since obviously  $A$  and  $B$  are coNP-complete (note that  $H$  is a tautology if and only if  $H \vee \neg H \models H$ ) we easily observe that  $\text{ENTAILMENT}_4$  is coNP-complete, whereas  $\text{ENTAILMENT}_1$  is NP-complete. Equally it is not hard to verify that both the second and the third component of the entailment classification problem are complete for DP where DP [PY84] is the class of all set differences of NP sets with NP sets.
2. The following generation principle is more fundamental. Let  $f$  and  $f'$  be functions with

$$\begin{aligned}
 f(1, 1) &= f'(0, 0) = 4, \\
 f(1, 0) &= f'(0, 1) = 3, \\
 f(0, 1) &= f'(1, 0) = 2, \\
 f(0, 0) &= f'(1, 1) = 1.
 \end{aligned}
 \tag{1.1}$$

We immediately see that **ENTAILMENT** is exactly the partition being generated when  $f$  is applied to the characteristic pair of the sets  $A$  and  $B$ . That means that for all propositional formulas  $H$  and  $H'$  it holds that  $c_{\text{ENTAILMENT}}(H, H') = f(c_A(H, H'), c_B(H, H'))$ . Dually, **ENTAILMENT** is the partition being generated when  $f'$  is applied to the complements of  $A$  and  $B$ . Since  $A$  and  $B$  are coNP sets partitions similar to **ENTAILMENT** emerge if we release  $A$  and  $B$  to be arbitrary coNP sets. In this manner the function  $f$  generates a whole class of partitions which we denote by  $\text{coNP}(f)$ . Dually we obtain a class  $\text{NP}(f')$  that is easily the same as  $\text{coNP}(f)$ . So **ENTAILMENT** belongs to the class  $\text{coNP}(f)$ . In fact, it is one of the hardest among all partitions in this class; it is in a sense complete for  $\text{coNP}(f)$ .

Both junctures of the entailment classification problem with the entailment decision problem make the boolean hierarchy over NP be involved in the study of complexity classes of partitions. On the one hand, the classes NP, coNP, and DP occurring as classes reflecting the computational difficulty of the projections of **ENTAILMENT** represent just the lowest levels of this complexity-theoretic hierarchy. On the other hand, the generation principle we described above is precisely the same as that that generates the boolean hierarchy over NP at all. Thus the boolean hierarchy is a suitable reference structure for our purposes.

### The Boolean Hierarchy (of Sets) over NP

The boolean hierarchy over NP has been very extensively investigated in, e.g., [WW85, CH86, KSW87, CGH<sup>+</sup>88, CGH<sup>+</sup>89, Cai87, Kad88, Wag90, RW98]. Purely set-theoretically, the boolean hierarchy over a set class is a very fundamental structure providing a detailed view on the closure of this class under the boolean operations intersection, union, and complementation. The roots of such hierarchies go back to Hausdorff [Hau14] who observed normal forms of sets belonging to the boolean closure of a set class. Underlining their great significance for computation theory, boolean hierarchies have been studied for much more classes than NP such as for 1NP (or US) [GW86], UP [HR97], C=P [GNW90, BCO93], RP [BBJ<sup>+</sup>89, BJY90], and partly for C=L [ABO99] in complexity theory, for the recursively enumerable sets [Ers68a, Ers68b] in recursion theory, or for classes occurring in automata theory [Wag79, BKS99, GS00].

The most general way to define the boolean hierarchy over NP is as follows (see [WW85]): For a boolean function  $f : \{0, 1\}^m \rightarrow \{0, 1\}$ , which represents combinations of boolean operations, and sets  $B_1, \dots, B_m$  let  $f(B_1, \dots, B_m)$  denote the set whose characteristic function satisfies that  $c_{f(B_1, \dots, B_m)}(x) = f(c_{B_1}(x), \dots, c_{B_m}(x))$  for all  $x$ . The class  $\text{NP}(f)$  consists of all sets  $f(B_1, \dots, B_m)$  when varying the sets  $B_i$  over NP. Up to the different ranges of functions and the different base classes this is just the generation principle we have used above to obtain a partition class capturing the complexity of **ENTAILMENT**. The boolean hierarchy over NP consists of all these classes  $\text{NP}(f)$ . Note that for the definition of the boolean hierarchy over NP it does not make a difference if we take NP or  $\text{coNP}$  as the base class; we clearly prefer NP. Wagner and Wechsung [WW85] have proved that every class  $\text{NP}(f)$  coincides with one of the classes  $\text{NP}(i)$  or  $\text{coNP}(i)$  where  $\text{NP}(i)$  is the class of all sets which are the symmetric difference of  $i$  NP sets and  $\text{coNP}(i)$  is the class of all complements of  $\text{NP}(i)$  sets. The family of these classes is also known as the difference hierarchy [KSW87]. Evidently,  $\text{DP} = \text{NP}(2)$ .

It is not known whether the boolean hierarchy over NP is finite or equivalently, whether  $\text{NP}(i) = \text{coNP}(i)$  for some  $i \geq 1$ . However, Kadin [Kad88] succeeded to prove that a finite boolean hierarchy over NP implies the finiteness of Meyer and Stockmeyer's polynomial hierarchy [MS72, Sto77]; an event which most researchers in computational complexity consider to be highly improbable.

### The Boolean Hierarchy of $k$ -Partitions over NP

Looking back at our example **ENTAILMENT** it is natural to introduce and to study the generalization of the boolean hierarchy of sets over NP to the case of partitions into  $k$  parts ( $k$ -partitions) for  $k \geq 3$ . Any set  $A$  is identified with the 2-partition  $(A, \overline{A})$ . For a function  $f : \{1, 2\}^m \rightarrow \{1, 2, \dots, k\}$  and sets (2-partitions)  $B_1, \dots, B_m$  we define a  $k$ -partition  $A = f(B_1, \dots, B_m)$  by the defining condition that  $c_A(x) = f(c_{B_1}(x), \dots, c_{B_m}(x))$  for all  $x$ . Note that the characteristic functions here are characteristic functions of partitions. The boolean hierarchy of  $k$ -partitions over NP consists of the classes

$$\text{NP}(f) =_{\text{def}} \{ f(B_1, \dots, B_m) \mid B_1, \dots, B_m \in \text{NP} \}.$$

As we have seen by **ENTAILMENT** this hierarchy enables to measure the computational complexity of classification problems based on relations for which the decision problems is in NP or  $\text{coNP}$ . The boolean hierarchy of sets now appears in this hierarchy as the special case  $k = 2$ .

Whereas the boolean hierarchy of sets over NP has a very simple structure (note that  $\text{NP}(i) \cup \text{coNP}(i) \subseteq \text{NP}(i+1) \cap \text{coNP}(i+1)$  for all  $i \geq 1$ ), the situation is much more complicated for the boolean hierarchy of  $k$ -partitions in the case  $k \geq 3$ . The main question is: Can we get an overview on the structure of this hierarchy? This question is not answered completely so far, but we will give partial answers, and we will establish a conjecture.

A function  $f : \{1, 2\}^m \rightarrow \{1, 2, \dots, k\}$  which defines the class  $\text{NP}(f)$  of  $k$ -partitions corresponds to the finite boolean lattice  $(\{1, 2\}^m, \leq)$  with the labeling function  $f$  where  $\leq$  means the vector-ordering on the set of all  $m$ -tuples of  $\{1, 2\}$ . Generalizing this idea we define for every finite lattice  $G$  with labeling function  $f : G \rightarrow \{1, 2, \dots, k\}$  (for short: the  $k$ -lattice  $(G, f)$ ) a class  $\text{NP}(G, f)$  of  $k$ -partitions. This does not result in more classes: For every  $k$ -lattice  $(G, f)$  there exists a finite function  $f'$  such that  $\text{NP}(G, f) = \text{NP}(f')$ . However,

the use of arbitrary lattices instead of only boolean lattices simplifies many considerations. In particular every class in the boolean hierarchy of  $k$ -partitions has a (essentially) unique description in terms of  $k$ -lattices. The above-mentioned difference hierarchy is just a special case of this description for the boolean hierarchy of 2-partitions.

To get an idea of the structure of the boolean hierarchy of  $k$ -partitions over NP it is very important to have a criterion to decide whether  $\text{NP}(G, f) \subseteq \text{NP}(G', f')$  for  $k$ -lattices  $(G, f)$  and  $(G', f')$ . For that we define a relation  $\leq$  as follows:

$$(G, f) \leq (G', f') \iff_{\text{def}} \text{ there is a monotonic } \varphi : G \rightarrow G' \text{ such that for all } x \in G, \\ f(x) = f'(\varphi(x)).$$

The Embedding Lemma says that  $(G, f) \leq (G', f')$  implies  $\text{NP}(G, f) \subseteq \text{NP}(G', f')$ , and the Embedding Conjecture expresses our conviction that the converse is also true unless the polynomial hierarchy is finite.

For the Embedding Conjecture there exists much evidence. For  $k = 2$  we can, not surprisingly, confirm this conjecture to be true. Moreover, we will give a theorem which enables us to verify the Embedding Conjecture for  $k \geq 3$  for a large class of  $k$ -lattices including all  $k$ -chains. The proof of this theorem uses a new chain-technique that extends Kadin's easy-hard arguments (cf. [Kad88]), developed for establishing the boolean and polynomial connection (for sets), to the case of partitions. Further the conjecture holds true for two subclasses of  $k$ -lattices where the chain-technique does not work. Here, two different proof techniques are needed that both are inspired by results from the theory of selective sets in [HHN<sup>+</sup>95, Ko83, HNOS96].

There is a machine-based approach to the boolean hierarchy of  $k$ -partitions over NP. Each partition belonging to some class  $\text{NP}(G, f)$  can be accepted in a natural way by nondeterministic polynomial-time machines with a notion of acceptance that depends on the  $k$ -lattice  $(G, f)$ . As a consequence one can show that all these classes possess complete partitions with respect to an appropriate many-one reduction. This reduction offers a translation of completeness from the whole partition onto the components. For instance, since **ENTAILMENT** is complete for  $\text{NP}(f')$  with  $f'$  as described in (1.1) we immediately obtain that each component of the partition **ENTAILMENT** is complete for the projection classes of  $\text{NP}(f')$ , i.e., **ENTAILMENT**<sub>1</sub> is NP-complete, **ENTAILMENT**<sub>2</sub> and **ENTAILMENT**<sub>3</sub> are NP(2)-complete, and **ENTAILMENT**<sub>4</sub> is coNP-complete, all as we have already discussed. However, there exists a partition, say  $A$ , which is complete for another partition class such that all components of  $A$  are complete for the same classes as the components of **ENTAILMENT** are, but neither  $A$  reduces to **ENTAILMENT** nor **ENTAILMENT** reduces to  $A$  in our partition sense unless NP is closed under complements. This nicely illustrates that the study of partitions allows finer distinctions between classification problems as in the case of restricting investigations to projections only.

## Refining the Boolean Hierarchy of $k$ -Partitions over NP

The boolean hierarchy of  $k$ -partitions provides a great variety of classes for which a concrete partition might be complete. Sometimes yet this hierarchy is too coarse. Let us make this point clear by a further example of a classification problem over a binary relation. Consider the embedding relation  $\hookrightarrow$  on finite graphs. For arbitrary graphs  $G = (V, E)$  and  $G' = (V', E')$  the embedding relation is defined as

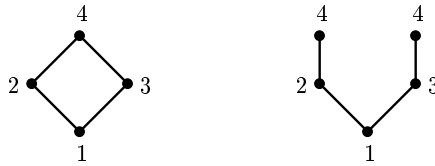

**Fig. 1.1.** ENTAILMENT versus GRAPH EMBEDDING

$$G \hookrightarrow G' \iff_{\text{def}} \text{there is an injective mapping } \varphi : V \rightarrow V' \text{ such that for all } u, v \in V, \\ (u, v) \in E \iff (\varphi(u), \varphi(v)) \in E'.$$

Deciding whether a graph  $G$  is embeddable into a graph  $G'$  is the SUBGRAPH ISOMORPHISM problem which is known to be NP-complete (cf. [GJ79]). As in the case of ENTAILMENT we specify the graph-embedding classification problem in that way that the first component is in NP. Let  $G$  and  $G'$  be finite graphs. Then define the characteristic function of the partition GRAPH EMBEDDING as follows

$$c_{\text{GRAPH EMBEDDING}}(G, G') =_{\text{def}} \begin{cases} 1 & \text{if } G \hookrightarrow G' \text{ and } G' \hookrightarrow G, \\ 2 & \text{if } G \hookrightarrow G' \text{ and } G' \not\hookrightarrow G, \\ 3 & \text{if } G \not\hookrightarrow G' \text{ and } G' \hookrightarrow G, \\ 4 & \text{if } G \not\hookrightarrow G' \text{ and } G' \not\hookrightarrow G. \end{cases}$$

Letting  $A$  be the set of all pairs of graphs  $G$  and  $G'$  such that  $G \hookrightarrow G'$  and  $B$  the set of all pairs of graphs  $G$  and  $G'$  with  $G' \hookrightarrow G$ , we again obtain that GRAPH EMBEDDING is in  $\text{NP}(f')$  where  $f'$  is the function from (1.1), that means that GRAPH EMBEDDING and ENTAILMENT belong to the same class. But since it is known that GRAPH ISOMORPHISM, which is just GRAPH EMBEDDING<sub>1</sub>, is not complete for NP unless the polynomial hierarchy collapses to its second level [Sch88], we conclude that GRAPH EMBEDDING cannot be complete for the partition class  $\text{NP}(f')$  unless the same polynomial-hierarchy collapse occur.

To shed more light on the differences between GRAPH EMBEDDING and ENTAILMENT we use a natural refinement of the boolean hierarchy of  $k$ -partitions over NP. As we know that each class defined by finite functions can be characterized by means of finite labeled lattices, one can most generally consider the family of all classes that are generated by finite labeled posets. Indeed, it turns out that GRAPH EMBEDDING is better captured by classes of this family which is called the refined boolean hierarchy of  $k$ -partitions over NP. Figure 1.1 shows on the left-hand side the 3-lattice that generates the partition class for which ENTAILMENT is complete and on the right-hand side the 3-poset (which is not a 3-lattice) that generates a partition class containing GRAPH EMBEDDING. It is interesting to observe that in our new terms a claimed completeness of GRAPH EMBEDDING for the same class for which ENTAILMENT is complete leads to a stronger consequence than the above-mentioned collapse of the polynomial hierarchy to its second level, namely to  $\text{NP} = \text{coNP}$ .

The classes in the refined boolean hierarchy of  $k$ -partitions can be structured in the same way as done in the boolean hierarchy of  $k$ -partitions. Note that the relation  $\leq$  we defined for  $k$ -lattices does not need the lattice property, hence can unalteredly be applied to  $k$ -posets. An according embedding lemma holds. As the boolean hierarchy of  $k$ -partitions is very



complicated, this applies more than ever to the refined version. To get complete information on the boolean hierarchy of  $k$ -partitions as intended by the Embedding Conjecture we need the additional complexity-theoretic assumption that the polynomial hierarchy is infinite. For the refined boolean hierarchy it is not even that true. There exist worlds in which the polynomial hierarchy is infinite but some classes in the refined boolean hierarchy of  $k$ -partitions over NP coincide that are expected to be different. However, the following weak embedding theorem holds: For  $k$ -posets  $(G, f)$  and  $(G', f')$  we have an inclusion  $\text{NP}(G, f) \subseteq \text{NP}(G', f')$  that is true in each possible world if and only if  $(G, f) \leq (G', f')$ . From this result one can conclude that in order to prove equalities additional to those that hold by the embedding lemma one has to use the very rare non-relativizable proof techniques, thus such equalities may be hard to find.

## Organization of the Thesis

This thesis is organized as follows:

- Chapter 2 contains the notions and concepts most important to us. First we gather basic mathematical notations concerning set theory and theory of orders and lattices. We further present complexity classes and hierarchies of complexity classes we will refer to in this thesis with particular emphasis on the boolean hierarchy over NP. Finally we make some conventions about partitions and we point out some peculiarities of handling partitions.
- In Chapter 3 we focus on our central subject: The boolean hierarchy of  $k$ -partitions over NP. We give a formal definition and some basic facts about the classes of this hierarchy. The main goal of this chapter is to gain an overview on the structure of the hierarchy. To this end we give an alternative characterization of partition classes generated by finite functions in terms of labeled lattices and we study the relation  $\leq$  on labeled lattices. We show that all classes have (essentially) unique descriptions by lattices. We derive and discuss the Embedding Conjecture which states that for  $k$ -lattices being in relation  $\leq$  is not only sufficient for inclusion of partition classes but also necessary unless the polynomial hierarchy is finite. A large part of the chapter is devoted to supporting the conjecture. Assuming the Embedding Conjecture is true we give an instructive example of how complicated the boolean hierarchy of  $k$ -partitions is already in the case  $k = 3$ . Finally we present a way to characterize partition classes generated by labeled lattices in terms of acceptance types for nondeterministic machines. This leads to reducibility notions and completeness concepts. This will be exemplified for ENTAILMENT.
- In Chapter 4 we refine the boolean hierarchy of  $k$ -partitions over NP by generalizing the approach of partition classes defined by lattices to partition classes defined by posets. We show that GRAPH EMBEDDING is in such a new class. We observe an alternative way to obtain partition classes over posets by considering partition classes generated by partial functions. Furthermore we investigate the maximal partition classes that have projections onto components of a certain complexity. We show that, given classes of the boolean hierarchy of sets as complexities of components of partitions, the largest partition class that has such components can be described by a labeled poset. The chapter ends with the prove of the relativized embedding theorem.
- Chapter 5 demonstrates that the study of the (refined) boolean hierarchy of  $k$ -partitions is not only interesting in its own as, e.g., a framework for measuring the complexity of

classification problems but has interesting connections to other research lines in computational complexity of sets as well as in computational complexity of functions. We discuss the relationships to the study of separable NP sets, we show that our approach to consider classes generated by  $k$ -posets lead in the case  $k = 2$  to very fine sub-hierarchies in low levels of the boolean hierarchy of sets over NP, and we resolve in some sense an open question concerning the possibility of reducing in a certain way output cardinalities of multi-valued NP functions.

## Publications

Some results of this thesis have been published in a refereed form in the papers:

- [KW00] S. Kosub and K. W. Wagner: The Boolean Hierarchy of NP-Partitions.  
In *Proceedings 17th Symposium on Theoretical Aspects of Computer Science*, volume 1770 of *Lecture Notes in Computer Science*, pages 157-168. Springer-Verlag, Berlin, 2000.
- [Kos00b] S. Kosub. On NP-Partitions over Posets with an Application to Reducing the Set of Solutions of NP Problems.  
In *Proceedings 25th Symposium on Mathematical Foundations of Computer Science*, volume 1893 of *Lecture Notes in Computer Science*, pages 467-476. Springer-Verlag, Berlin, 2000.

All results presented in this thesis can be found in these publications and in the technical reports [KW99, Kos00a, Kos00c, Kos00d]:

- Chapter 3 is completely covered by [KW99, KW00].
- All sections of Chapter 4 are contained in [Kos00b, Kos00c] except Section 4.3 which is included in [Kos00a].
- The content of Chapter 5 is from [Kos00d] (Section 5.1), [Kos00a] (Section 5.2), and [Kos00b, Kos00c] (Section 5.3).

## 2. Preliminaries

In this chapter we describe the basic concepts and notions that are used throughout this thesis. We assume the reader to be familiar with basic set-theory and logic as well as with the concept of Turing machines.

### 2.1 Mathematical Notions and Notations

We gather in this section some conventions and facts about mathematical notions we will tacitly adopt in the forthcoming.

#### 2.1.1 Sets, Functions, and Words

Let  $\mathbb{N} = \{0, 1, 2, \dots\}$  be the set of all natural numbers, and let  $\mathbb{N}_+$  be the set of all positive natural numbers, i.e.,  $\mathbb{N}_+ = \{1, 2, \dots\}$ .

The empty set is denoted by  $\emptyset$ . For an arbitrary finite set  $A$ , its cardinality is denoted by  $\|A\|$ . Let  $A$  and  $B$  be any sets. Then  $A \setminus B$  denotes the difference of  $A$  with  $B$ , i.e., the set of all elements that are in  $A$  but not in  $B$ . The symmetric difference of  $A$  and  $B$  is denoted by  $A \Delta B$ , i.e.,  $A \Delta B = (A \setminus B) \cup (B \setminus A)$ .  $A \times B$  denotes the cartesian product, i.e., the set of all pairs  $(a, b)$  with  $a \in A$  and  $b \in B$ . For  $m \in \mathbb{N}_+$ , define

$$A^m \stackrel{\text{def}}{=} \underbrace{A \times \cdots \times A}_{m \text{ times}}.$$

Let  $M$  be any fixed basic set. The set of all subsets of  $M$  is denoted by  $\mathcal{P}(M)$ . For a set  $A \subseteq M$ , its complement in the basic set  $M$  is denoted by  $\overline{A}$ , i.e.,  $\overline{A} = M \setminus A$ . The characteristic function  $c_A : M \rightarrow \{0, 1\}$  is defined for all  $x \in M$  as

$$c_A(x) \stackrel{\text{def}}{=} \begin{cases} 1 & \text{if } x \in A, \\ 0 & \text{if } x \in \overline{A}. \end{cases}$$

Let  $\mathcal{K}$  and  $\mathcal{K}'$  be classes of subsets of  $M$ , i.e.,  $\mathcal{K}, \mathcal{K}' \subseteq \mathcal{P}(M)$ . We define

$$\begin{aligned} \text{co}\mathcal{K} &\stackrel{\text{def}}{=} \{ \overline{A} \mid A \in \mathcal{K} \}, \\ \mathcal{K} \wedge \mathcal{K}' &\stackrel{\text{def}}{=} \{ A \cap B \mid A \in \mathcal{K}, B \in \mathcal{K}' \}, \\ \mathcal{K} \vee \mathcal{K}' &\stackrel{\text{def}}{=} \{ A \cup B \mid A \in \mathcal{K}, B \in \mathcal{K}' \}, \\ \mathcal{K} \oplus \mathcal{K}' &\stackrel{\text{def}}{=} \{ A \Delta B \mid A \in \mathcal{K}, B \in \mathcal{K}' \}. \end{aligned}$$

$\text{BC}(\mathcal{K})$  is the boolean closure of  $\mathcal{K}$ , i.e., the smallest class which contains  $\mathcal{K}$  and which is closed under intersection, union, and complements.

Let  $M$  and  $M'$  be any sets, and let  $f : M \rightarrow M'$  by any function. The domain of  $f$  is denoted by  $D_f$ , i.e.,  $D_f = \{x \in M \mid f(x) \text{ defined}\}$ . The function  $f$  is total if  $D_f = M$ . For a set  $A \subseteq D_f$ , let  $f(A) = \{f(x) \mid x \in A\}$ . In particular, the range of  $f$  which is denoted by  $R_f$  is the set  $f(D_f)$ . For a set  $A \subseteq M$ , the restriction of  $f$  to  $A$  is denoted by  $f|_A$  and is defined for all  $x \in M$  as

$$f|_A(x) \stackrel{\text{def}}{=} \begin{cases} f(x) & \text{if } x \in A \cap D_f, \\ \text{not defined} & \text{otherwise.} \end{cases}$$

The inverse of  $f$  is denoted by  $f^{-1}$ , i.e.,  $f^{-1} : B \rightarrow \mathcal{P}(M)$  such that for all  $y \in B$ ,  $f^{-1}(y) = \{x \in M \mid f(x) = y\}$ . If  $f^{-1}(y)$  is at most a singleton then we omit the braces. We use  $\text{id}_M$  to denote the identity map on  $M$  given by  $\text{id}_M(x) = x$  for all  $x \in M$ .

If  $f$  and  $f'$  are functions with  $f : M \rightarrow M'$  and  $f' : M' \rightarrow M''$ , then  $(f' \circ f)$  is the function mapping from  $M$  to  $M''$  which is defined for all  $x \in M$  as

$$(f' \circ f)(x) \stackrel{\text{def}}{=} f'(f(x)).$$

Let  $m \in \mathbb{N}_+$ . If  $f$  maps  $M$  to itself, then  $f^m : M \rightarrow M$  is the function defined for all  $x \in M$  as

$$f^m(x) \stackrel{\text{def}}{=} \underbrace{(f \circ \dots \circ f)}_{m \text{ times}}(x).$$

Let  $M = \{a, b\}$  with  $a \neq b$ . For  $x \in M$ , define  $\bar{x}$  to be  $a$  if  $x = b$ , and  $b$  if  $x = a$ . For any function  $f : M^m \rightarrow M'$  with  $m \in \mathbb{N}_+$ , let  $f^\partial$  denote its dual function, i.e., that function defined for all  $x = (x_1, \dots, x_m) \in M^m$  as

$$f^\partial(x_1, \dots, x_m) \stackrel{\text{def}}{=} f(\bar{x}_1, \dots, \bar{x}_m).$$

The vector  $(\bar{x}_1, \dots, \bar{x}_m)$  is denoted by  $\bar{x}$ .

We will make no difference between  $m$ -tuples  $(x_1, \dots, x_m)$  over a finite set  $M$  and words  $x_1 \dots x_m$  of length  $m$  over  $M$ . Such finite sets are called alphabets. We fix the finite alphabet  $\Sigma = \{0, 1\}$  for considerations about input-output behavior of machines. More generally, let  $\Delta$  be any finite alphabet.  $\Delta^*$  is the set of all finite words that can be built with letters from  $\Delta$ . For  $x, y \in \Delta^*$ ,  $x \cdot y$  (or  $xy$  for short) denotes the concatenation of  $x$  and  $y$ . The empty word is denoted by  $\varepsilon$ . For a given word  $x = x_1 \dots x_m$  the reversed word  $x_m \dots x_1$  is denoted by  $x^R$ . For  $x \in \Delta^*$ ,  $|x|$  denotes the length of  $x$ . For  $n \in \mathbb{N}$ ,  $\Delta^{\leq n}$  is the set of all words  $x \in \Delta^*$  with  $|x| \leq n$ , and  $\Delta^{=n}$  is the set of all words  $x \in \Delta^*$  with  $|x| = n$ . For any letter  $a \in \Delta$  and any word  $x \in \Delta^*$ ,  $|x|_a$  denotes the number of occurrences of  $a$  in the word  $x$ . If the alphabet  $\Delta$  is ordered by  $\leq$ , then let  $\leq_{\text{lex}}$  denote the standard lexicographical order on  $\Delta^*$ , that is, for each  $x, y \in \Delta^*$ ,  $x \leq_{\text{lex}} y$  if and only if (a)  $x = y$ , (b)  $|x| < |y|$ , or (c)  $|x| = |y|$  and there is an  $i$  with  $x_j = y_j$  for all  $j \in \{1, \dots, i-1\}$  but  $x_i < y_i$ . Usually we consider words  $x$  and  $y$  of the same length  $n$  to be partially ordered by the vector-ordering, i.e.,  $x \leq y$  iff  $x_i \leq y_i$  for all  $i \in \{1, \dots, n\}$ .

## 2.1.2 Orders and Lattices

In more detail the following can be found in any textbook (e.g., [Grä78, DP90]) about theory of orders and lattices.

Let  $G$  be any set. A partial order on  $G$  (or order, for short) is a binary relation  $\leq$  on  $G$  that is reflexive, antisymmetric, and transitive. The set  $G$  equipped with a partial order  $\leq$  is said to be a poset (or, more copiously, a partially ordered set). Usually, we talk about the poset  $G$ . Where it is necessary we write  $(G, \leq)$  to specify the order.

A poset  $G$  is a chain if for all  $x, y \in G$  it holds that  $x \leq y$  or  $y \leq x$  (i.e., any two elements are comparable with respect to  $\leq$ ). For instance, the set  $\Delta^*$  equipped with  $\leq_{\text{lex}}$  is a chain. A poset  $G$  is an antichain if for all  $x, y \in G$  it holds that  $x \leq y$  implies that  $x = y$  (i.e., no two elements are comparable with respect to  $\leq$ ).

For every poset  $G$ , the order  $\leq$  on  $G$  is also an order on each subset  $G'$  of  $G$ . We say that  $G'$  is a subposet of  $G$ .  $G^\partial$  denotes the dual poset of a poset  $G$ , i.e., the poset for which we define  $x \leq y$  to hold in  $G^\partial$  if and only if  $x \geq y$  holds in  $G$ .

Finite posets are usually represented in diagrams. Diagrams are based on the covering relation  $\prec$ . Let  $G$  be a poset and let  $x, y \in G$ . We say that  $x$  is covered by  $y$  (or  $y$  covers  $x$ ), and write  $x \prec y$ , if  $x < y$  and  $x \leq z < y$  implies that  $x = z$ . The latter condition is demanding that there be no element  $z$  of  $G$  with  $x < z < y$ . A finite poset  $G$  can be drawn in a diagram consisting of points (representing the elements of  $G$ ) and interconnecting lines (indicating the covering relation) as follows: To each element  $x$  in  $G$  associate a point  $P(x)$  in the picture which is above all points  $P(y)$  associated to elements  $y$  less than  $x$ , and connect points  $P(x)$  and  $P(y)$  by a line if and only if  $x \prec y$ . Note that a poset can have different representation by diagrams. Basically, the whole of an infinite poset cannot be drawn in a diagram. However, infinite posets of a sufficiently regular structure can often be suggested diagrammatically, as it is usually done by the help of dots for extrapolating the structure.

Very often it is needed mapping between posets such that structures are preserved. Let  $G$  and  $G'$  be posets. A map  $\varphi : G \rightarrow G'$  is said to be monotonic (or order-preserving) if  $x \leq y$  in  $G$  implies  $\varphi(x) \leq \varphi(y)$  in  $G'$ . We say that  $\varphi$  is an order-embedding if  $\varphi$  is monotonic and injective, and we say that  $\varphi$  is an order-isomorphism if  $\varphi$  is monotonic, injective, and surjective.

Two posets  $G$  and  $G'$  are isomorphic, in symbols  $G \cong G'$ , if there exists an order-isomorphism  $\varphi : G \rightarrow G'$ . It is easily seen that  $G \cong G'$  if and only if there exist monotonic maps  $\varphi : G \rightarrow G'$  and  $\psi : G' \rightarrow G$  such that  $\psi \circ \varphi = \text{id}_G$  and  $\varphi \circ \psi = \text{id}_{G'}$ . Isomorphic poset shall be considered to be not essentially different: Two finite posets are isomorphic if and only if they can be drawn with identical diagrams.

Let  $G$  be a poset, and let  $G' \subseteq G$ . An element  $x \in G$  is an upper bound of  $G'$  if  $y \leq x$  for all  $y \in G'$ . Dually,  $x$  is a lower bound if  $x \leq y$  for all  $y \in G'$ . If  $G' = G$  then an upper bound is called a maximal element  $G$ , and a lower bound is called a minimal element of  $G$ . If  $G'$  has a least upper bound  $x$ , then  $x$  is called the supremum of  $G'$ , and if  $G'$  has greatest lower bound  $x$ , then  $x$  is called the infimum of  $G'$ . Clearly, the supremum and infimum are always unique. The supremum of  $G$  itself, if it exists, is denoted by  $1_G$ , and the infimum of  $G$  itself, if it exists, is denoted by  $0_G$ . As usual, we write  $x \vee y$  (read “ $x$  join  $y$ ”) to denote the supremum of  $\{x, y\}$  when it exists, and we write  $x \wedge y$  (read “ $x$  meet  $y$ ”) to denote the infimum of  $\{x, y\}$  when it exists. Similarly, we write  $\bigvee G'$  (the join of  $G'$ ) and  $\bigwedge G'$  (the meet of  $G'$ ) to denote the supremum of  $G'$  when it exists, and the infimum of  $G$  when it exists.

A poset  $G$  is a lattice if  $x \vee y$  and  $x \wedge y$  exist for all  $x, y \in G$ . Obviously, every chain is a lattice. Easily, one can show that for a finite poset  $G$  to be a lattice is equivalent to  $1_G$  exists and  $x \wedge y \in G$  exists for all  $x, y \in G$ . For each  $x \in G$ , the set  $\{y \in G \mid y \leq x\}$  as well as the set  $\{y \in G \mid x \leq y\}$  are again lattices.

Let  $G$  be a lattice. An element  $x \neq 1_G$  is said to be meet-irreducible if for all  $y, z \in G$ ,  $x = y \wedge z$  implies  $x = y$  or  $x = z$ . In a diagram the meet-irreducible elements are those that have only one line to an upper neighbor, or more formally, that are covered only by one element.

A lattice  $G$  with  $0_G \neq 1_G$  is a boolean lattice if  $G$  is isomorphic to any power-set lattice  $(\mathcal{P}(S), \subseteq)$ .

## 2.2 Complexity Classes and Hierarchies

We will now fix our complexity-theoretic setting. The following can be found in part in any standard textbook on theory of computation or computational complexity theory (e.g., [WW86, BDG90, BDG95, Odi99]).

The basic computational model we refer to is the standard Turing machine (for a formal description see, e.g., [WW86, BDG95]). We consider nondeterministic and deterministic versions of Turing machines. A nondeterministic Turing machine is said to be categorical if the machine on each input always has at most one accepting computation path. A Turing machine that can produce outputs on a special output tape is called a Turing transducer. We also consider Turing machines that have the possibility to access oracles on an additional tape. All notions that will be mentioned translate accordingly to such oracle Turing machines. If we consider an oracle Turing machine  $M$  accessing an oracle  $A$  then this is denoted by  $M^A$ .

Polynomial-time Turing machines are Turing machines that for a fixed polynomial  $p$ , make on every input  $x$  at most  $p(|x|)$  computation steps before reaching a final state. In case of a nondeterministic polynomial-time Turing machine  $M$ , the set of all words accepted by  $M$ , denoted by  $L(M)$ , is the set of all words  $x \in \Sigma^*$  for which  $M$ , on input  $x$ , has at least one computation path of at most  $p(|x|)$  steps of running, that ends in an accepting final state.

FP denotes the class of all functions that are computable by a deterministic polynomial-time Turing transducer. The class FP is appropriate for comparing sets with respect to their complexity. We say that a set  $A \subseteq \Sigma^*$  is polynomial-time many-one reducible to a set  $B \subseteq \Sigma^*$ , in symbols  $A \leq_m^p B$ , if and only if there exists a function  $f \in \text{FP}$  such that for all  $x \in \Sigma^*$ ,

$$x \in A \iff f(x) \in B.$$

Let  $\mathcal{C} \subseteq \mathcal{P}(\Sigma^*)$ .  $\mathcal{C}$  is closed under  $\leq_m^p$  if for all  $A, B \subseteq \Sigma^*$  it holds that  $A \leq_m^p B$  and  $B \in \mathcal{C}$  imply that  $A \in \mathcal{C}$ . A set  $A$  is  $\leq_m^p$ -complete for  $\mathcal{C}$  if  $A \in \mathcal{C}$  and  $B \leq_m^p A$  for all  $B \in \mathcal{C}$ .

We implicitly use the following correspondence val between  $\Sigma^*$  and  $\mathbb{N}$ : For  $x \in \Sigma^*$ ,

$$\text{val}(x) \stackrel{\text{def}}{=} \left\| \left\{ y \in \Sigma^* \mid y <_{\text{lex}} x \right\} \right\|.$$

Note that val is polynomial-time computable and invertible.

It is often needed to encode tuples of words of  $\Sigma^*$  into one word of  $\Sigma^*$ . Let  $\langle \cdot, \cdot \rangle_2$  denote a standard polynomial-time computable and polynomial-time invertible pairing function on finite words (e.g., based on self-delimiting words; cf. [LV97]). This pairing function is used to define encodings of  $m$ -tuples for arbitrary  $m \in \mathbb{N}_+$ :

$$\langle x_1, \dots, x_m \rangle \stackrel{\text{def}}{=} \langle m, \langle x_1, \langle \dots, \langle x_{m-1}, x_m \rangle_2 \dots \rangle_2 \rangle_2.$$

Conversely, if a word  $\langle x_1, \dots, x_m \rangle \in \Sigma^*$  is given then the function  $\pi_j^m$  denotes the projection to the  $j$ -th component of the  $m$ -tuple, i.e.,  $\pi_j^m(\langle x_1, \dots, x_m \rangle) = x_j$ . If  $h$  is any function mapping

from  $\Delta^*$  to  $\Sigma^*$ , then we define the function  $\langle \pi_{i_1}^m, \dots, \pi_{i_n}^m \rangle \circ h : \Delta^* \rightarrow \Sigma^*$  with  $n \leq m$  to be for all  $x \in \Delta^*$ ,

$$\langle \pi_{i_1}^m, \dots, \pi_{i_n}^m \rangle \circ h(x) =_{\text{def}} \langle \pi_{i_1}^m(h(x)), \dots, \pi_{i_n}^m(h(x)) \rangle.$$

The following notions are due to Karp and Lipton [KL80]. Let  $\text{poly}$  denote the class of all functions  $f : \mathbb{N} \rightarrow \Sigma^*$  such that there exists a polynomial  $p$  with  $|f(n)| \leq p(n)$  for all  $n \in \mathbb{N}$ . Let  $\mathcal{C}$  be a class of sets in  $\Sigma^*$ . Then the class  $\mathcal{C}/\text{poly}$  is the class of all sets  $A$  for which there exist a set  $B \in \mathcal{C}$  and a function  $f \in \text{poly}$  (the so-called advice function) such that for all  $x \in \Sigma^*$ ,

$$x \in A \iff \langle x, f(|x|) \rangle \in B.$$

Let  $\text{REC}$  denote the class of all recursive sets, i.e., those sets that can be decided by deterministic Turing machines.  $\text{RE}$  denotes the class of all recursively enumerable sets, i.e., the class of all sets that are ranges of deterministic Turing transducers. It is well known that  $\text{REC}$  is strictly included in  $\text{RE}$  and that  $\text{RE}$  has the following characterization: A set  $A$  is in  $\text{RE}$  if and only if there exists a set  $B \in \text{REC}$  such that for all  $x \in \Sigma^*$ ,

$$x \in A \iff (\exists y)[\langle x, y \rangle \in B].$$

### 2.2.1 NP and Its Relatives

$\text{NP}$  is the class of all sets  $A \subseteq \Sigma^*$  for which there exists a nondeterministic polynomial-time Turing machine  $M$  with  $A = L(M)$ . Similar to the class of the recursively enumerable sets,  $\text{NP}$  can be characterized as the class of all sets  $A \subseteq \Sigma^*$  for which there exist a set  $B$  and a polynomial  $p$  such that for all  $x \in \Sigma^*$ ,

$$x \in A \iff (\exists y, |y| = p(|x|))[\langle x, y \rangle \in B].$$

$\text{NP}$  has some closure properties. So  $\text{NP}$  is closed under  $\leq_m^p$ -reductions. Moreover,  $\text{NP}$  is closed under intersection and union. Since  $\emptyset$  and  $\Sigma^*$  are in  $\text{NP}$  this can be formulated as

$$\text{NP} \wedge \text{NP} = \text{NP} \vee \text{NP} = \text{NP}.$$

The same holds for the class  $\text{coNP}$  of all complements of  $\text{NP}$  sets.

For  $B \subseteq \Sigma^*$ ,  $\text{NP}^B$  denotes the class of all sets  $A$  for which there exists a nondeterministic polynomial-time oracle Turing machine  $M$  such that  $A = L(M^B)$ . All properties we mentioned so far for  $\text{NP}$  are relativizable properties, i.e., they all hold for each class  $\text{NP}^B$ . In contrast to this, there exist sets  $B$  and  $C$  where  $\text{NP}^B = \text{coNP}^B$  (i.e.,  $\text{NP}$  is closed under complements relative to  $B$ ) and  $\text{NP}^C \neq \text{coNP}^C$  (i.e.,  $\text{NP}$  is not closed under complements relative to  $C$ ). However, in the unrelativized case, it is not known whether  $\text{NP}$  is closed under complements.

$\text{SATISFIABILITY}$ , denoting the set of all (encodings of) satisfiable propositional formulas, is an example of a set  $\leq_m^p$ -complete for  $\text{NP}$ .  $\text{TAUTOLOGY}$ , denoting the set of all (encodings of) tautological propositional formulas, is an example of a set  $\leq_m^p$ -complete for  $\text{coNP}$ . Observe that  $\text{SATISFIABILITY}$  and  $\text{TAUTOLOGY}$  have some self-reducibility properties. For any propositional formula  $H = H(x_0, x_1, \dots, x_m)$  and  $\alpha \in \{0, 1\}$  let  $H_\alpha$  denote the formula defined as

$$H_\alpha(x_1, \dots, x_m) \stackrel{\text{def}}{=} H(\alpha, x_1, \dots, x_m).$$

Then it is easily observed that

$$\begin{aligned} H \in \text{SATISFIABILITY} &\iff H_0 \in \text{SATISFIABILITY} \vee H_1 \in \text{SATISFIABILITY}, \\ H \in \text{TAUTOLOGY} &\iff H_0 \in \text{TAUTOLOGY} \wedge H_1 \in \text{TAUTOLOGY}. \end{aligned}$$

P denotes the class of all sets decidable by deterministic Turing machines in polynomial time. P is closed under  $\leq_m^p$ , is closed under intersection and union, and P is closed under complementation. Obviously,  $P \subseteq \text{NP}$  and more general,  $P^B \subseteq \text{NP}^B$  for every  $B \subseteq \Sigma^*$ . Although most researches in complexity theory believe that the unrelativized inequality is strict, it is still an open question whether this in fact holds. However, it is known that there exist sets  $B$  and  $C$  such that  $P^B = \text{NP}^B$  and  $P^C \subseteq \text{NP}^C$ .

For any class  $\mathcal{C} \subseteq \mathcal{P}(\Sigma^*)$ , let  $P^{\mathcal{C}}$  and  $\text{NP}^{\mathcal{C}}$  denote the classes defined as

$$P^{\mathcal{C}} \stackrel{\text{def}}{=} \bigcup_{B \in \mathcal{C}} P^B \quad \text{and} \quad \text{NP}^{\mathcal{C}} \stackrel{\text{def}}{=} \bigcup_{B \in \mathcal{C}} \text{NP}^B.$$

UP denotes the class of all sets  $A$  for which there exists a categorical polynomial-time Turing machines  $M$  with  $A = L(M)$ . UP is closed under  $\leq_m^p$  and under intersection. Obviously,  $\text{UP} \subseteq \text{NP}$  and more general  $\text{UP}^A \subseteq \text{NP}^A$ . It is not known whether  $\text{UP} = \text{NP}$  and it is also an open problem whether  $\text{coUP} \subseteq \text{NP}$  (or equivalently,  $\text{UP} \subseteq \text{coNP}$ ). For both question there exist falsifying relativizations.

### 2.2.2 The Polynomial Hierarchy

The polynomial hierarchy is built inductively on P.

- $\Delta_0^p \stackrel{\text{def}}{=} P$ ,  $\Sigma_0^p \stackrel{\text{def}}{=} P$ , and  $\Pi_0^p \stackrel{\text{def}}{=} P$ .
- For  $m \in \mathbb{N}_+$ , let  $\Delta_m^p \stackrel{\text{def}}{=} P^{\Sigma_{m-1}^p}$ ,  $\Sigma_m^p \stackrel{\text{def}}{=} \text{NP}^{\Sigma_{m-1}^p}$ , and  $\Pi_m^p \stackrel{\text{def}}{=} \text{co}\Sigma_m^p$ .
- $\text{PH} \stackrel{\text{def}}{=} \bigcup_{m \in \mathbb{N}} \Sigma_m^p$ .

As is standard the term polynomial hierarchy is used simultaneously for the class PH and the family of all classes  $\Delta_m^p$ ,  $\Sigma_m^p$ , and  $\Pi_m^p$  for  $m \in \mathbb{N}$ . Each class in the polynomial hierarchy is closed under  $\leq_m^p$ , possesses sets  $\leq_m^p$ -complete for it, and is closed under intersection and union.

The relations among the classes of the polynomial hierarchy with respect to set inclusions can be gathered in the following inclusion chain:

$$P \subseteq \dots \subseteq \Delta_m^p \subseteq \Sigma_m^p \cap \Pi_m^p \subseteq \Sigma_m^p \cup \Pi_m^p \subseteq \Delta_{m+1}^p \subseteq \dots \subseteq \text{PH}.$$

Though the question of whether the polynomial hierarchy collapses or not is still open, many conditions are known under which the polynomial hierarchy does collapse. In particular, the polynomial hierarchy is known to have the upward collapse property. Let  $m \in \mathbb{N}$ .

- $\Sigma_m^p = \Pi_m^p \implies \text{PH} = \Sigma_m^p$ .
- $\Sigma_m^p = \Sigma_{m+1}^p \implies \text{PH} = \Sigma_m^p$ .
- $\Delta_m^p = \Sigma_m^p \implies \text{PH} = \Sigma_m^p$ .



The classes in the polynomial hierarchy admit relativizations. Let  $B \subseteq \Sigma^*$ . Then we can build a polynomial hierarchy relative to  $B$  by starting with classes, e.g.,  $\Sigma_0^p(B) = P^B$ , and then further,  $\Sigma_m^p(B) = NP^{\Sigma_{m-1}^p(B)}$  for  $m \in \mathbb{N}_+$ , and so on. Since each of the upward collapses is relativizable, i.e., does hold for the polynomial hierarchy relative to any set, there exists an oracle  $B$  such that  $\text{PH} = P$  relative to  $B$ . On the other hand, it is known that there exist sets  $B_m$  such that relative to  $B_m$  the polynomial hierarchy collapses to its  $m$ -th level but not before [Ko89], and there exists an oracle  $B$  such that the polynomial hierarchy is strict [Yao85].

The polynomial hierarchy has become a very important reference structure, i.e., many investigations has been made under the assumption that the polynomial hierarchy does not collapse. For instance, it is closely related to the study of nonuniform complexity classes:

- $NP \subseteq P/\text{poly} \implies \text{PH} = \Delta_2^p$ ,
- $NP \subseteq \text{coNP}/\text{poly} \implies \text{PH} = \Sigma_3^p$ .

### 2.2.3 The Boolean Hierarchy

The notion of the boolean hierarchy over some class  $\mathcal{K}$  being closed under union and intersection in concept can be found in the work of Hausdorff [Hau14]. It has been introduced into complexity theory via the boolean hierarchy over  $NP$  in various ways.

Let  $M$  be any fixed basic set. Let  $\mathcal{K}$  be such that  $\emptyset, M \in \mathcal{K}$  and  $\mathcal{K}$  is closed under intersection and union. The classes  $\mathcal{K}(m)$  and  $\text{co}\mathcal{K}(m)$  defined by

$$\mathcal{K}(0) =_{\text{def}} \{\emptyset\} \quad \text{and} \quad \mathcal{K}(m+1) =_{\text{def}} \mathcal{K}(m) \oplus \mathcal{K} \quad \text{for } m \in \mathbb{N}$$

build the *boolean hierarchy over  $\mathcal{K}$* .<sup>1</sup> There are many equivalent definitions (cf. [WW85, CH86, KSW87, CGH<sup>+</sup>88]). Some of them can be found in the following theorem.

**Theorem 2.1.** *Let  $\emptyset, M \in \mathcal{K}$ , let  $\mathcal{K}$  be closed under intersection and union, and let  $m \in \mathbb{N}_+$ .*

1.  $\mathcal{K}(2m-1) = \{ A_1 \cup \bigcup_{j=1}^{m-1} (A_{2j+1} \setminus A_{2j}) \mid A_1, \dots, A_{2m-1} \in \mathcal{K} \text{ and } A_1 \subseteq \dots \subseteq A_{2m-1} \}$ .
2.  $\mathcal{K}(2m) = \{ \bigcup_{j=1}^m (A_{2j} \setminus A_{2j-1}) \mid A_1, \dots, A_{2m} \in \mathcal{K} \text{ and } A_1 \subseteq \dots \subseteq A_{2m} \}$ .
3.  $\mathcal{K}(2m) = \mathcal{K}(2m-1) \wedge \text{co}\mathcal{K}$ .
4.  $\mathcal{K}(2m+1) = \mathcal{K}(2m) \vee \mathcal{K}$ .
5.  $\mathcal{K}(m+1) = \text{co}\mathcal{K}(m) \wedge \mathcal{K}$ .
6.  $\mathcal{K}(m+2) = \mathcal{K}(m) \vee (\mathcal{K} \wedge \text{co}\mathcal{K}) = \mathcal{K}(m) \wedge (\mathcal{K} \vee \text{co}\mathcal{K})$ .

Note that the conditions we assumed for this theorem are essential as has been shown by Hemaspaandra and Rothe [HR97] for the case  $\mathcal{K} = \text{UP}$  which is not known to be closed under union.

The inclusion structure among the classes of the boolean hierarchy is as follows (see also Figure 2.1):

$$\mathcal{K}(m) \cup \text{co}\mathcal{K}(m) \subseteq \mathcal{K}(m+1) \cap \text{co}\mathcal{K}(m+1).$$

It depends on the class  $\mathcal{K}$  whether the hierarchy is finite. For instance, if  $\mathcal{K}$  is closed under complements then clearly, the hierarchy collapses to its first level. Generally, the boolean hierarchy over  $\mathcal{K}$  has the upward collapse property as well. Let  $m \in \mathbb{N}_+$

<sup>1</sup> Usually for  $\mathcal{K} = NP$ , a level 0 is not considered in the way we do. The zero-level there is  $P$ . However for our purposes it is more helpful to regard  $P$  not as an element of the boolean hierarchy (unless  $P = NP$ ).

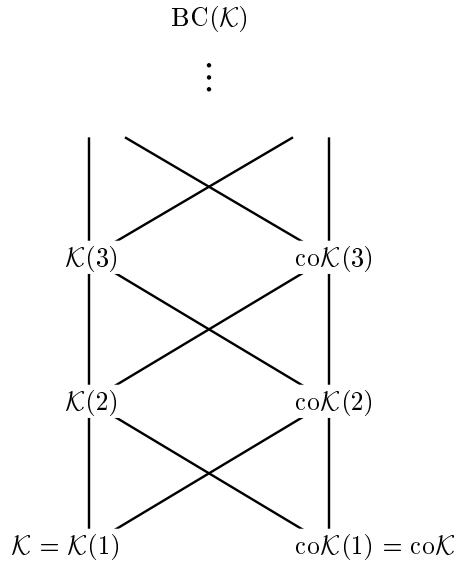

**Fig. 2.1.** The non-trivial levels of the boolean hierarchy over  $\mathcal{K}$

- $\mathcal{K}(m) = \text{co}\mathcal{K}(m) \implies \text{BC}(\mathcal{K}) = \mathcal{K}(m)$ .
- $\mathcal{K}(m) = \mathcal{K}(m+1) \implies \text{BC}(\mathcal{K}) = \mathcal{K}(m)$ .

Recall that  $\text{BC}(\mathcal{K})$  is the boolean closure of  $\mathcal{K}$ , i.e., the union of all classes  $\mathcal{K}(f)$  for functions  $f : \{0, 1\}^m \rightarrow \{0, 1\}$  defined as follows. Let  $B_1, \dots, B_m \in \mathcal{K}$ . Then  $f(B_1, \dots, B_m)$  is the set defined by

$$c_{f(B_1, \dots, B_m)}(x) = f(c_{B_1}(x), \dots, c_{B_m}(x))$$

for all  $x \in M$ . Then

$$\mathcal{K}(f) \stackrel{\text{def}}{=} \{ f(B_1, \dots, B_m) \mid B_1, \dots, B_m \in \mathcal{K} \}.$$

Using the so-called mind-change technique, developed by Wagner [Wag79] and later applied in, e.g., [WW85, Wag90, Bei91], one can precisely determine with which class of the boolean hierarchy over  $\mathcal{K}$  a class  $\mathcal{K}(f)$  for a given function  $f$  coincides.

**Theorem 2.2.** [WW85] *Let  $f : \{0, 1\}^m \rightarrow \{0, 1\}$ . Consider  $\{0, 1\}^m$  to be partially ordered by the vector-ordering. Let  $\mu(f)$  denote the maximal number  $n$  such that there exist  $a_0, \dots, a_n \in \{0, 1\}^m$  with  $a_0 < \dots < a_n$  and for all  $j \in \{1, \dots, n\}$ ,  $f(a_{j-1}) \neq f(a_j)$ . Then*

$$\mathcal{K}(f) = \begin{cases} \mathcal{K}(\mu(f)) & \text{if } f(0^m) = 0, \\ \text{co}\mathcal{K}(\mu(f)) & \text{if } f(0^m) = 1. \end{cases}$$

The classes of the boolean hierarchy over NP are all closed under  $\leq_m^p$  and all have sets  $\leq_m^p$ -complete for them. Moreover, each class can be accepted by nondeterministic polynomial-time Turing machines with modified acceptance type (see [WW85]). No class in the boolean hierarchy except NP and coNP is simultaneously closed under both intersection and union unless the hierarchy is finite.

It is not known whether the boolean hierarchy over NP is infinite. However, a collapse of the boolean hierarchy over NP to any level implies a collapse of the polynomial hierarchy [Kad88]. Since the proof is relativizable we immediately obtain that there exists an oracle  $B$  such that the boolean hierarchy over  $\text{NP}^B$  is strict.

The boolean hierarchy over NP is interwoven with the number-of-query hierarchy introduced by Wagner [Wag87, Wag89, Wag90]. Let  $\text{P}_{\parallel}^{\text{NP}}[m]$  denote the class of all sets  $A \subseteq \Sigma^*$  for which there exist a set  $B \in \text{NP}$  and deterministic polynomial-time oracle Turing machine  $M^{(\cdot)}$  such that  $A = L(M^B)$  and for all  $x \in \Sigma^*$ ,  $M^B$ , on input  $x$ , asks at most  $m$  queries to  $B$  in a parallel manner (i.e., all queries to  $B$  have to be fixed before the first query is asked). It is known that  $\text{P}_{\parallel}^{\text{NP}}[m] = \text{P} \oplus \text{NP}(m)$  [Wag98]. Hence, we immediately have the following relational structure with the boolean hierarchy over NP:

$$\text{NP}(m) \cup \text{coNP}(m) \subseteq \text{P}_{\parallel}^{\text{NP}}[m] \subseteq \mathcal{K}(m+1) \cap \text{co}\mathcal{K}(m+1).$$

Boolean hierarchies over NP or, more generally, over classes  $\Sigma_m^p$  have been further enhanced by the extended boolean hierarchy of Wagner [Wag90] and the typed boolean hierarchy of Selivanov [Sel94a, Sel95].

## 2.3 Partitions

We will only consider partitions of fixed natural number  $k$  of components for  $k \geq 2$ .

Let  $M$  be any set. A  $k$ -tuple  $A = (A_1, \dots, A_k)$  with  $A_i \subseteq M$  for each  $i \in \{1, \dots, k\}$  is said to be a  $k$ -partition of  $M$  if and only if

$$\bigcup_{i=1}^k A_i = M \quad \text{and} \quad A_i \cap A_j = \emptyset \quad \text{for all } i, j \text{ with } i \neq j.$$

The set  $A_i$  is said to be the  $i$ -th component of  $A$ . For two  $k$ -partitions  $A$  and  $B$  to be equal it is sufficient that  $A_i \subseteq B_i$  for all  $i \in \{1, \dots, k\}$ . The characteristic function  $c_A : M \rightarrow \{1, \dots, k\}$  of a  $k$ -partition  $A$  is defined for all  $x \in M$  as

$$c_A(x) = i \iff_{\text{def}} x \in A_i.$$

For  $\mathcal{C}_1, \dots, \mathcal{C}_k \subseteq \mathcal{P}(M)$  let

$$(\mathcal{C}_1, \dots, \mathcal{C}_k) =_{\text{def}} \{ A \mid A \text{ is } k\text{-partition of } M \text{ and } A_i \in \mathcal{C}_i \text{ for all } i \in \{1, \dots, k\} \}.$$

We say that  $(\mathcal{C}_1, \dots, \mathcal{C}_k)$  is a bound representation of a partition class. Note that a partition class can have infinitely many bound representations. For instance,  $(\text{P}, \mathcal{C}) = (\mathcal{C}, \text{P}) = (\text{P}, \text{P})$  for all  $\text{P} \subseteq \mathcal{C}$ .

Let  $\mathcal{C}$  be a class of  $k$ -partitions. For  $i \in \{1, \dots, k\}$  let

$$\mathcal{C}_i =_{\text{def}} \{ A_i \mid A \in \mathcal{C} \}$$

be the  $i$ -th projection class of  $\mathcal{C}$ . The partition class  $(\mathcal{C}_1, \dots, \mathcal{C}_k)$  is the *projective closure* of  $\mathcal{C}$ . This term is justified since the operator  $\Pi$  defined as  $\Pi(\mathcal{C}) = (\mathcal{C}_1, \dots, \mathcal{C}_k)$  clearly satisfies  $\mathcal{C} \subseteq \Pi(\mathcal{C})$ ,  $\mathcal{C} \subseteq \mathcal{C}' \Rightarrow \Pi(\mathcal{C}) \subseteq \Pi(\mathcal{C}')$ , and  $\Pi(\Pi(\mathcal{C})) = \Pi(\mathcal{C})$ , thus all conditions of a closure

operator. A partition class with  $\mathcal{C} = \Pi(\mathcal{C})$  is said to be *projectively closed*. Note that only projectively closed classes of  $k$ -partitions can have a bound representation (see also Example 2.4).

In many cases it suffices to specify  $k - 1$  components of a class of  $k$ -partitions. This leads to free representations of partition classes. For classes  $\mathcal{C}_1, \dots, \mathcal{C}_{k-1}$  of subsets of  $M$  let

$$(\mathcal{C}_1, \dots, \mathcal{C}_{k-1}, \cdot) \stackrel{\text{def}}{=} (\mathcal{C}_1, \dots, \mathcal{C}_{k-1}, \mathcal{P}(M)).$$

Note that only for the sake of convenience we define free representations with respect to the last component. Each freely represented partition classes can be boundly represented.

**Proposition 2.3.** *For all classes  $\mathcal{C}_1, \dots, \mathcal{C}_{k-1}$  of subsets of  $M$ ,*

$$(\mathcal{C}_1, \dots, \mathcal{C}_{k-1}, \cdot) = \left( \mathcal{C}_1, \dots, \mathcal{C}_{k-1}, \text{co} \bigvee_{i=1}^{k-1} \mathcal{C}_i \right).$$

We should remark that Proposition 2.3 does not express that  $(\mathcal{C}_1, \dots, \mathcal{C}_{k-1}, \cdot)_k$  is equal to  $\text{co} \bigvee_{i=1}^{k-1} \mathcal{C}_i$ .

We make the convention that a set  $A$  is identified with the 2-partition  $(A, \overline{A})$  and a class of set  $\mathcal{C}$  is, boundly represented, identified with the class  $(\mathcal{C}, \text{co}\mathcal{C})$  of 2-partitions or is, freely represented, identified with the class  $(\mathcal{C}, \cdot) = (\cdot, \text{co}\mathcal{C})$  of 2-partitions. For instance,  $\text{NP} = (\text{NP}, \text{coNP}) = (\text{NP}, \cdot)$ . Classes of 2-partitions are always projectively closed since for every set  $A$  its complement  $\overline{A}$  is uniquely determined. In contrast, for  $k \geq 3$  different class of  $k$ -partitions may have equal projection class as illustrated by the following example.

**Example 2.4.** Let  $M = \{1, 2\}$ . Define  $\mathcal{C}$  and  $\mathcal{D}$  to be the following classes of 3-partitions:

$$\begin{aligned} \mathcal{C} &\stackrel{\text{def}}{=} \{ (\{1\}, \emptyset, \{2\}), (\emptyset, \{2\}, \{1\}), (\{1, 2\}, \emptyset, \emptyset) \}, \\ \mathcal{D} &\stackrel{\text{def}}{=} \mathcal{C} \cup \{ (\{1\}, \{2\}, \emptyset) \}. \end{aligned}$$

Then it is easily seen that

$$\begin{aligned} \mathcal{C}_1 &= \mathcal{D}_1 = \{ \emptyset, \{1\}, \{1, 2\} \}, \\ \mathcal{C}_2 &= \mathcal{D}_2 = \{ \emptyset, \{2\} \}, \\ \mathcal{C}_3 &= \mathcal{D}_3 = \{ \emptyset, \{1\}, \{2\} \} \end{aligned}$$

but on the other hand  $\mathcal{C} \neq \mathcal{D}$ . Note that  $\mathcal{D} = (\mathcal{D}_1, \mathcal{D}_2, \mathcal{D}_3)$ , that is  $\mathcal{D}$  is projectively closed.

### 3. The Boolean Hierarchy of NP-Partitions

In this chapter we introduce the boolean hierarchy of  $k$ -partitions over NP for  $k \geq 3$  as a generalization of the boolean hierarchy of sets (i.e., 2-partitions) over NP. Whereas the structure of the latter hierarchy is rather simple the structure of the boolean hierarchy of  $k$ -partitions over NP for  $k \geq 3$  turns out to be much more complicated. The main goal of this chapter is to get a complete idea of this structure. To this end we give an alternative characterization of classes from the boolean hierarchy of  $k$ -partitions in terms of labeled lattices and we define a relation on labeled lattices for comparing partition classes by means of labeled lattices. We derive and discuss the Embedding Conjecture expressing that this relation induces not only a sufficient condition for inclusions of partition classes but also a necessary one unless the polynomial hierarchy collapses. The conjecture is supported by several partial results. Assuming the Embedding Conjecture is true we illustrate how complicated the boolean hierarchy of  $k$ -partitions is already in the case  $k = 3$ . Finally we characterize partition classes generated by labeled lattices by a machine-based approach. We define a notion of reducibility (and thus, of completeness) and exemplify this notion for the entailment classification problem.

#### 3.1 Partition Classes Defined by Finite Functions

Let  $\mathcal{K}$  be a class of subsets of  $M$  such that  $\emptyset, M \in \mathcal{K}$  and  $\mathcal{K}$  is closed under intersection and union. As we have seen in Section 2.2.3 one way to define the classes of the boolean hierarchy of sets over  $\mathcal{K}$  is as follows. Let  $f : \{1, 2\}^m \rightarrow \{1, 2\}$  be a boolean function. For  $B_1, \dots, B_m \in \mathcal{K}$  the set  $f(B_1, \dots, B_m)$  is defined by  $c_{f(B_1, \dots, B_m)}(x) = f(c_{B_1}(x), \dots, c_{B_m}(x))$ . Then the classes  $\mathcal{K}(f) =_{\text{def}} \{ f(B_1, \dots, B_m) \mid B_1, \dots, B_m \in \mathcal{K} \}$  form the boolean hierarchy over  $\mathcal{K}$ . Using finite functions  $f : \{1, 2\}^m \rightarrow \{1, 2, \dots, k\}$  we generalize this definition (remember in which sense sets are 2-partitions) to obtain the classes of the boolean hierarchy of  $k$ -partitions over  $\mathcal{K}$  as follows.

**Definition 3.1.** Let  $k \geq 2$ .

1. For any function  $f : \{1, 2\}^m \rightarrow \{1, 2, \dots, k\}$  with  $m \geq 1$  and for sets  $B_1, \dots, B_m \in \mathcal{K}$ , the  $k$ -partition  $f(B_1, \dots, B_m)$  is defined such that for all  $x \in M$ ,

$$c_{f(B_1, \dots, B_m)}(x) = f(c_{B_1}(x), \dots, c_{B_m}(x)).$$

2. For any function  $f : \{1, 2\}^m \rightarrow \{1, 2, \dots, k\}$  with  $m \geq 1$ , the *class of  $k$ -partitions over  $\mathcal{K}$  defined by  $f$*  is given by the class

$$\mathcal{K}(f) =_{\text{def}} \{ f(B_1, \dots, B_m) \mid B_1, \dots, B_m \in \mathcal{K} \}.$$

3. The *boolean hierarchy of  $k$ -partitions over  $\mathcal{K}$*  is defined to be the family

$$\text{BH}_k(\mathcal{K}) =_{\text{def}} \{ \mathcal{K}(f) \mid f : \{1, 2\}^m \rightarrow \{1, 2, \dots, k\} \text{ and } m \geq 1 \}.$$

4.  $\text{BC}_k(\mathcal{K}) =_{\text{def}} \bigcup \text{BH}_k(\mathcal{K})$ .

Obviously if  $i \in \{1, 2, \dots, k\}$  is not a value of  $f : \{1, 2\}^m \rightarrow \{1, 2, \dots, k\}$  then  $\mathcal{K}(f)_i = \{\emptyset\}$ , that is  $\mathcal{K}(f)$  does not really have an  $i$ -th component. Therefore we assume in what follows that  $f$  is surjective.

The following proposition shows that every partition in  $\mathcal{K}(f)$  consists of sets from the boolean hierarchy over  $\mathcal{K}$ . This also justifies the use of the term *boolean* in the above definition.

**Proposition 3.2.** *Let  $k \geq 2$  and let  $f : \{1, 2\}^m \rightarrow \{1, 2, \dots, k\}$  be any function with  $m \geq 1$ .*

1.  $(\mathcal{K}, \dots, \mathcal{K}) \subseteq \mathcal{K}(f) \subseteq (\text{BC}(\mathcal{K}), \dots, \text{BC}(\mathcal{K}))$ .
2. If  $\mathcal{K}$  is closed under complements then  $\mathcal{K}(f) = (\mathcal{K}, \dots, \mathcal{K})$ .
3.  $\text{BC}_k(\mathcal{K}) = (\text{BC}(\mathcal{K}), \dots, \text{BC}(\mathcal{K}))$ .

*Proof.*

1. We first show that  $\mathcal{K}(f) \subseteq (\text{BC}(\mathcal{K}), \dots, \text{BC}(\mathcal{K}))$ . Let  $B_1, \dots, B_m$  be sets in  $\mathcal{K}$ , and consider the  $k$ -partition  $A = f(B_1, \dots, B_m)$ . For each  $i \in \{1, 2, \dots, k\}$ , we obtain

$$x \in A_i \iff \bigvee_{f(a_1 \dots a_m) = i} \bigwedge_{j=1}^m c_{B_j}(x) = a_j$$

and consequently

$$A_i = \bigcup_{f(a_1 \dots a_m) = i} \left[ \left( \bigcap_{a_i=1} B_j \right) \setminus \left( \bigcup_{a_i=2} B_j \right) \right]. \quad (3.1)$$

Clearly, this gives  $A_i \in \mathcal{K}(2 \cdot \|f^{-1}(i)\|)$ .

Now we prove  $(\mathcal{K}, \dots, \mathcal{K}) \subseteq \mathcal{K}(f)$ . Let  $A$  be a  $k$ -partition in  $(\mathcal{K}, \dots, \mathcal{K})$ . For every  $i \in \{1, 2, \dots, k\}$ , fix some  $v_i \in \{1, 2\}^m$  such that  $f(v_i) = i$ . Define for all  $j \in \{1, 2, \dots, m\}$ , sets  $B_j$  as

$$B_j =_{\text{def}} \bigcup_{v_i \leq 2^{j-1} 12^{m-j}} A_i.$$

It is easily observed that for all  $a_1 \dots a_m \in \{1, 2\}^m$ ,

$$\bigcap_{a_j=1} B_j = \bigcup_{v_l \leq a_1 \dots a_m} A_l \quad \text{and} \quad \bigcup_{a_j=2} B_j = \bigcup_{v_l < a_1 \dots a_m} A_l.$$

By Equation (3.1) we obtain  $A = f(B_1, \dots, B_m)$ .

2. This statement is an immediate consequence of the first one.

3. The inclusion  $\text{BC}_k(\mathcal{K}) \subseteq (\text{BC}(\mathcal{K}), \dots, \text{BC}(\mathcal{K}))$  follows directly from 1. For the converse inclusion let  $A \in (\text{BC}(\mathcal{K}), \dots, \text{BC}(\mathcal{K}))$ , i.e., there exists an  $r \geq 1$  such that for all  $i \in \{1, 2, \dots, k\}$ ,  $A_i \in \mathcal{K}(r)$ . Hence there exist sets  $B_1, \dots, B_{k \cdot r} \in \mathcal{K}$  such that for all  $i \in \{1, 2, \dots, k\}$ ,

$$A_i = B_{(i-1) \cdot r + 1} \Delta B_{(i-1) \cdot r + 2} \Delta \dots \Delta B_{i \cdot r}.$$

Observe that for every  $a_1 \dots a_{k \cdot r}$ , there exists an  $i \in \{1, 2, \dots, k\}$  such that

$$\left( \bigcap_{a_j=1} B_j \right) \cap \left( \bigcap_{a_j=2} \overline{B_j} \right) \subseteq A_i.$$

Thus, we can define  $f : \{1, 2\}^{k \cdot r} \rightarrow \{1, 2, \dots, k\}$  such that for all  $a_1 \dots a_{k \cdot r} \in \{1, 2\}^{k \cdot r}$ ,

$$f(a_1 \dots a_{k \cdot r}) = i \iff_{\text{def}} \left( \bigcap_{a_j=1} B_j \right) \cap \left( \bigcap_{a_j=2} \overline{B_j} \right) \subseteq A_i,$$

and we obtain  $A = f(B_1, \dots, B_{k \cdot r})$ . □

For  $k = 2$  the classes  $\mathcal{K}(f)$  of the boolean hierarchy  $\text{BH}_2(\mathcal{K})$  of sets (2-partitions) have been completely characterized in terms of the maximal number of mind changes of  $f$ . Each class  $\mathcal{K}(f)$  coincides with a class  $\mathcal{K}(m)$  or  $\text{co}\mathcal{K}(m)$  according to Theorem 2.2. Consequently,

$$\text{BH}_2(\mathcal{K}) = \{ \mathcal{K}(m) \mid m \in \mathbb{N}_+ \} \cup \{ \text{co}\mathcal{K}(m) \mid m \in \mathbb{N}_+ \},$$

and given a function  $f : \{1, 2\}^m \rightarrow \{1, 2\}$  it is easy to determine the class  $\mathcal{K}(m)$  or  $\text{co}\mathcal{K}(m)$  which coincides with  $\mathcal{K}(f)$ . As already mentioned, the classes of  $\text{BH}_2(\mathcal{K})$  form a simple structure with respect to set inclusion. There do not exist three classes in  $\text{BH}_2(\mathcal{K})$  which are incomparable in this sense.

It is the goal of this chapter to get insights into the structure of the boolean hierarchy  $\text{BH}_k(\text{NP})$  of  $k$ -partitions over NP for  $k \geq 3$ . What we can say at this point is, that already for  $k = 3$  the structure of  $\text{BH}_k(\text{NP})$  with respect to set inclusion is not as simple as for  $k = 2$  (unless  $\text{NP} = \text{coNP}$ ). This is shown by the following example.

**Example 3.3.** For  $a, b, c$  such that  $\{a, b, c\} = \{1, 2, 3\}$  define the function  $f_{abc} : \{1, 2\}^2 \rightarrow \{1, 2, 3\}$  by  $f_{abc}(11) = a$ ,  $f_{abc}(12) = f_{abc}(21) = b$ , and  $f_{abc}(22) = c$ . Obviously,  $\text{NP}(f_{abc})_a = \text{NP}$ ,  $\text{NP}(f_{abc})_b = \text{NP}(2)$ , and  $\text{NP}(f_{abc})_c = \text{coNP}$ . Now let  $abc \neq a'b'c'$ . If  $\text{NP}(f_{abc}) = \text{NP}(f_{a'b'c'})$  then  $\text{NP} = \text{NP}(2)$  or  $\text{NP} = \text{coNP}$ , or  $\text{NP}(2) = \text{coNP}$ . In each of these cases we obtain  $\text{NP} = \text{coNP}$ . Consequently, if  $\text{NP} \neq \text{coNP}$  the six classes  $\text{NP}(f_{abc})$  are pairwise incomparable with respect to set inclusion.

Definition 3.1 refers to a set class  $\mathcal{K}$  with  $\emptyset, M \in \mathcal{K}$  and which is closed under intersection and union. As  $\mathcal{K}$  so  $\text{co}\mathcal{K}$  easily satisfies these conditions as well. Thus, all the definitions can be applied to  $\text{co}\mathcal{K}$ . The following theorem shows that there is a very close connection between classes from  $\text{BH}_k(\mathcal{K})$  and classes from  $\text{BH}_k(\text{co}\mathcal{K})$ .

**Theorem 3.4.**  $\mathcal{K}(f) = \text{co}\mathcal{K}(f^\partial)$  for all  $f : \{1, 2\}^m \rightarrow \{1, 2, \dots, k\}$  with  $m \geq 1$  and  $k \geq 2$ .

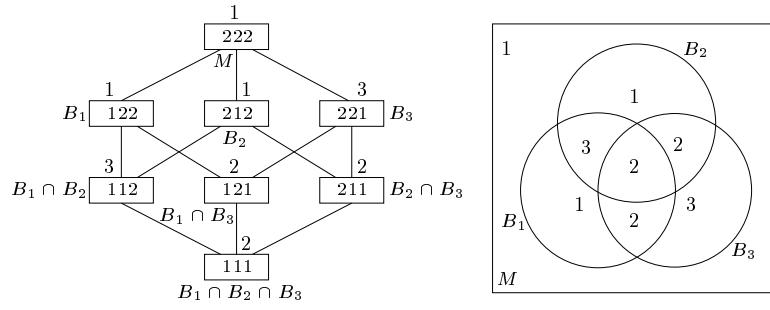

Fig. 3.1. Partition defined by a boolean 3-lattice

*Proof.* By symmetry, it suffices to show  $\mathcal{K}(f) \subseteq \text{co}\mathcal{K}(f^\partial)$ . Therefore, consider a partition  $A \in \mathcal{K}(f)$ . Then there are sets  $B_1, \dots, B_m \in \mathcal{K}$  such that  $A = f(B_1, \dots, B_m)$ . Since for all  $a_1 \dots a_m \in \{1, 2\}^m$ ,  $f(a_1 \dots a_m) = f^\partial(\overline{a_1} \dots \overline{a_m})$ , we obtain that for all  $x \in M$ ,

$$f(c_{B_1}(x), \dots, c_{B_m}(x)) = f^\partial(c_{\overline{B_1}}(x), \dots, c_{\overline{B_m}}(x)).$$

This gives  $A = f(B_1, \dots, B_m) = f^\partial(\overline{B_1}, \dots, \overline{B_m})$ . Hence,  $A \in \text{co}\mathcal{K}(f^\partial)$ . □

In particular,  $\text{BH}_k(\mathcal{K})$  and  $\text{BH}_k(\text{co}\mathcal{K})$  coincide even if  $\mathcal{K}$  is not closed under complements.

**Corollary 3.5.**  $\text{BH}_k(\mathcal{K}) = \text{BH}_k(\text{co}\mathcal{K})$  for all  $k \geq 2$ .

### 3.2 Partition Classes Defined by Lattices

It turns out that, for  $f : \{1, 2\}^m \rightarrow \{1, 2, \dots, k\}$ , a  $k$ -partition  $f(B_1, \dots, B_m)$  has a very natural equivalent lattice-theoretical definition. Consider the boolean lattice  $\{1, 2\}^m$  with the partial vector-ordering  $\leq$ , and consider the function  $S : \{1, 2\}^m \rightarrow \mathcal{K}$  defined by

$$S(a_1, \dots, a_m) =_{\text{def}} \bigcap_{a_i=1} B_i,$$

where we define an intersection over an empty index set to be  $M$ . For an example see Figure 3.1. Note that  $S(2, \dots, 2) = M$  and  $S(a \wedge b) = S(a) \cap S(b)$  for all  $a, b \in \{1, 2\}^m$ . Defining

$$T_S(a) =_{\text{def}} S(a) \setminus \bigcup_{b < a} S(b)$$

we obtain the  $i$ -th component of  $f(B_1, \dots, B_m)$  as

$$f(B_1, \dots, B_m)_i = \bigcup_{f(a)=i} T_S(a),$$

i.e.,  $f(B_1, \dots, B_m)$  can also be given by the function  $S : \{1, 2\}^m \rightarrow \mathcal{K}$ .

On the other side, if we have any function  $S : \{1, 2\}^m \rightarrow \mathcal{K}$  such that  $S(2, \dots, 2) = M$  and  $S(a \wedge b) = S(a) \cap S(b)$  for all  $a, b \in \{1, 2\}^m$  we can define

$$B_j =_{\text{def}} S(2^{j-1}12^{m-j}) \quad \text{for } j \in \{1, 2, \dots, m\},$$



and we obtain for  $i \in \{1, 2, \dots, k\}$

$$f(B_1, \dots, B_m)_i = \bigcup_{f(a)=i} T_S(a).$$

In this manner the class  $\mathcal{K}(f)$  of  $k$ -partitions is completely characterized by the labeled boolean lattice  $((\{1, 2\}^m, \leq), f)$ .

In this section we will see that classes of  $k$ -partitions can also be defined by weaker structures than boolean algebras. Again we always suppose  $\mathcal{K}$  to be a class such that  $\emptyset, M \in \mathcal{K}$  and which is closed under intersection and union.

**Definition 3.6.** Let  $G$  be a lattice.

1. A mapping  $S : G \rightarrow \mathcal{K}$  is said to be a  $\mathcal{K}$ -homomorphism on  $G$  if and only if
  - a)  $S(1_G) = M$  and
  - b)  $S(a \wedge b) = S(a) \cap S(b)$  for all  $a, b \in G$ .
2. For a  $\mathcal{K}$ -homomorphism  $S$  on  $G$  and  $a \in G$ , let

$$T_S(a) =_{\text{def}} S(a) \setminus \bigcup_{b < a} S(b).$$

**Lemma 3.7.** Let  $G$  be a lattice, and let  $S$  be a  $\mathcal{K}$ -homomorphism on  $G$ .

1.  $T_S(a) \in \mathcal{K} \wedge \text{co}\mathcal{K}$  for every  $a \in G$ .
2.  $S(a) = \bigcup_{b \leq a} T_S(b)$  for every  $a \in G$ .
3. The set of all  $T_S(a)$  for  $a \in G$  yields a partition of  $M$ .
4.  $S$  is completely determined by its values for the meet-irreducible elements. That is, if  $S$  and  $S'$  are two  $\mathcal{K}$ -homomorphisms on  $G$  such that  $S(a) = S'(a)$  for all meet-irreducible  $a \in G$  then  $S(a) = S'(a)$  for all  $a \in G$ .

*Proof.*

1. Observe  $T_S(a) = S(a) \cap \overline{\bigcup_{b < a} S(b)} \in \mathcal{K} \wedge \text{co}\mathcal{K}$  since  $\mathcal{K}$  is closed under union.
2. The direction “ $\supseteq$ ” is obvious since  $T_S(b) \subseteq S(b) \subseteq S(a)$  for  $b \leq a$ . The converse inclusion can be verified by induction on  $<$ . Obviously,  $S(0_G) = T_S(0_G)$ . For  $a > 0_G$  we obtain

$$S(a) = T_S(a) \cup \bigcup_{b < a} S(b) = T_S(a) \cup \bigcup_{b < a} \bigcup_{c \leq b} T_S(c) = T_S(a) \cup \bigcup_{c < a} T_S(c) = \bigcup_{c \leq a} T_S(c).$$

3. We have to show that every  $x \in M$  is contained in exactly one  $T_S(a)$ . Proving the existence of such an  $a \in G$ , define

$$H =_{\text{def}} \{ a \mid x \in S(a) \}$$

which is non-empty since  $\bigcup_{a \in G} S(a) = M$ . Since  $G$  is finite it follows that  $x \in S(\bigwedge H)$ . Let  $b < \bigwedge H$ . Then  $b \notin H$ , and hence  $x \notin S(b)$ . So,  $x \in S(\bigwedge H) \setminus \bigcup_{b < \bigwedge H} S(b) = T_S(\bigwedge H)$ . To show the uniqueness assume that there is an  $a \neq \bigwedge H$  such that  $x \in T_S(a)$ . Then  $x \in S(a)$  and hence  $a \in H$ . Consequently,  $a > \bigwedge H$  and we obtain  $x \notin S(a) \setminus \bigcup_{b < a} S(b) = T_S(a)$ , a contradiction.

4. This is an immediate consequence of the definition of meet-irreducible elements and the condition  $S(a \wedge b) = S(a) \cap S(b)$  for  $\mathcal{K}$ -homomorphisms. □

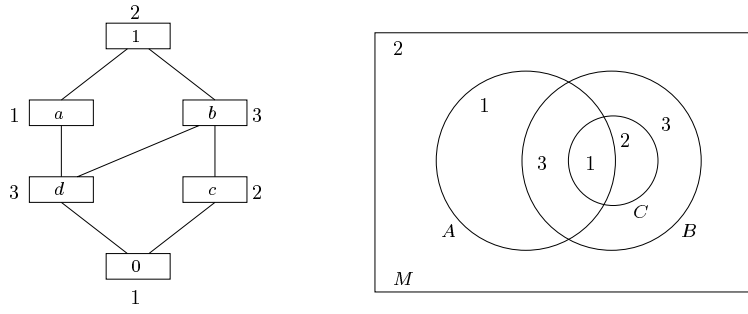

**Fig. 3.2.** Partition defined by a 3-lattice

Any pair  $(G, f)$  of an arbitrary finite poset  $G$  and a function  $f : G \rightarrow \{1, 2, \dots, k\}$  is called a  $k$ -poset. A  $k$ -poset which is a lattice (boolean lattice) is called a  $k$ -lattice (boolean  $k$ -lattice, resp.).

Lemma 3.7 provides the soundness of the following definition.

**Definition 3.8.** Let  $(G, f)$  be a  $k$ -lattice,  $k \geq 2$ .

1. For a  $\mathcal{K}$ -homomorphism  $S$  on  $G$ , the  $k$ -partition defined by  $(G, f)$  and  $S$  is given by

$$(G, f, S) =_{\text{def}} \left( \bigcup_{f(a)=1} T_S(a), \dots, \bigcup_{f(a)=k} T_S(a) \right).$$

2. The class of  $k$ -partitions defined by  $(G, f)$  is given by

$$\mathcal{K}(G, f) =_{\text{def}} \{ (G, f, S) \mid S \text{ is } \mathcal{K}\text{-homomorphism on } G \}.$$

**Example 3.9.** Consider the 3-lattice  $(G, f)$  in Figure 3.2. The meet-irreducible elements of  $G$  are  $a, b$ , and  $c$ . By point 4 of Lemma 3.7 every  $\mathcal{K}$ -homomorphism  $S : G \rightarrow \mathcal{K}$  is determined by fixing  $S(a) = A$ ,  $S(b) = B$ , and  $S(c) = C$ . By the definition of  $\mathcal{K}$ -homomorphisms we get  $S(1) = M$ ,  $S(d) = S(a \wedge b) = S(a) \cap S(b) = A \cap B$ , and  $S(0) = S(d \wedge c) = S(d) \cap S(c) = A \cap B \cap C$ . Furthermore,  $C = S(c) = S(c \wedge b) = S(c) \cap S(b) = C \cap B$ , i.e.,  $C \subseteq B$ . We obtain

$$\begin{aligned} T_S(1) &= M \setminus (A \cup B) &= \overline{A} \cap \overline{B}, \\ T_S(a) &= A \setminus (A \cap B) &= A \cap \overline{B}, \\ T_S(b) &= B \setminus ((A \cap B) \cup C) &= \overline{A} \cap B \cap \overline{B}, \\ T_S(c) &= C \setminus (A \cap B \cap C) &= \overline{A} \cap C, \\ T_S(d) &= (A \cap B) \setminus (A \cap B \cap C) &= A \cap B \cap \overline{C}, \\ T_S(0) &= (A \cap B \cap C) &= A \cap C. \end{aligned}$$

Hence

$$\begin{aligned} (G, f, S) &= (T_S(a) \cup T_S(0), T_S(1) \cup T_S(c), T_S(b) \cup T_S(d)) \\ &= (A \cap (\overline{B} \cup C), \overline{A} \cap (\overline{B} \cup C), B \cap \overline{C}), \end{aligned}$$

and

$$\begin{aligned} \mathcal{K}(G, f) &= \{ (A \cap (\overline{B} \cup C), \overline{A} \cap (\overline{B} \cup C), B \cap \overline{C}) \mid A, B, C \in \mathcal{K} \text{ and } C \subseteq B \} \\ &\subseteq (\mathcal{K}(3), \text{co}\mathcal{K}(3), \mathcal{K}(2)). \end{aligned}$$

The discussion at the beginning of the section yields the following proposition.

**Proposition 3.10.**  $\mathcal{K}(f) = \mathcal{K}(\{\{1, 2\}^m, \leq\}, f)$  for all  $f : \{1, 2\}^m \rightarrow \{1, 2, \dots, k\}$  with  $m \geq 1$  and  $k \geq 2$ .

So, if  $(G, f)$  is a boolean  $k$ -lattice then  $\mathcal{K}(G, f) = \mathcal{K}(f)$ . But if  $(G, f)$  is an arbitrary  $k$ -lattice, is  $\mathcal{K}(G, f)$  also of the form  $\mathcal{K}(f')$  for a suitable function  $f'$ ? The following theorem says that this is generally true. This turns out to be very important for the further study of the structure of the boolean hierarchy of  $k$ -partitions because instead of large boolean  $k$ -lattices one can handle with usually much smaller equivalent  $k$ -lattices.

**Theorem 3.11.** For every  $k$ -lattice  $(G, f)$  there is an  $f' : \{1, 2\}^m \rightarrow \{1, 2, \dots, k\}$  with  $\mathcal{K}(G, f) = \mathcal{K}(f')$ , where  $m$  is the number of meet-irreducible elements of  $G$ .

We postpone the proof of this theorem to Section 3.3 where we can make use of the Embedding Lemma (Lemma 3.14).

**Corollary 3.12.**  $\text{BH}_k(\mathcal{K}) = \{ \mathcal{K}(G, f) \mid (G, f) \text{ is a } k\text{-lattice} \}$  for all  $k \geq 2$ .

### 3.3 Comparing Partition Classes

To study the structure of the boolean hierarchy of  $k$ -partitions over  $\mathcal{K}$  it would be important to have a criterion to decide whether  $\mathcal{K}(G, f) \subseteq \mathcal{K}(G', f')$  for any two  $k$ -lattices  $(G, f)$  and  $(G', f')$ . To this end we establish, more generally, a relation  $\leq$  between  $k$ -posets.

**Definition 3.13.** Let  $(G, f)$  and  $(G', f')$  be  $k$ -posets with  $k \geq 2$ .

1.  $(G, f) \leq (G', f')$  if and only if there is a monotonic mapping  $\varphi : G \rightarrow G'$  such that for every  $x \in G$ ,  $f(x) = f'(\varphi(x))$ .
2.  $(G, f) \equiv (G', f')$  if and only if  $(G, f) \leq (G', f')$  and  $(G', f') \leq (G, f)$ .

The following lemma gives a sufficient condition for  $\mathcal{K}(G, f) \subseteq \mathcal{K}(G', f')$ .

**Lemma 3.14. (Embedding Lemma.)** Let  $(G, f)$  and  $(G', f')$  be  $k$ -lattices with  $k \geq 2$ . If  $(G, f) \leq (G', f')$ , then  $\mathcal{K}(G, f) \subseteq \mathcal{K}(G', f')$ .

*Proof.* Let  $(G, f)$  and  $(G', f')$  be  $k$ -lattices with  $(G, f) \leq (G', f')$ . Let  $\varphi : G \rightarrow G'$  be a monotonic mapping such that  $f(a) = f'(\varphi(a))$  for every  $a \in G$ . For a  $\mathcal{K}$ -homomorphism  $S$  on  $G$  define the mapping  $S' : G' \rightarrow \mathcal{K}$  for all  $a \in G'$  by

$$S'(a) =_{\text{def}} \bigcup_{\varphi(b) \leq' a} S(b).$$

It is sufficient to prove that  $S'$  is a  $\mathcal{K}$ -homomorphism on  $G'$ , i.e., that

1.  $S'(1_{G'}) = M$ ,
2.  $S'(a \wedge' b) = S'(a) \cap S'(b)$  for all  $a, b \in G'$ ,
3.  $T_S(a) \subseteq T_{S'}(\varphi(a))$  for all  $a \in G$ .

This can be shown as follows:

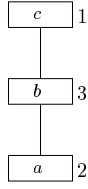

**Fig. 3.3.** A 3-chain equivalent to the boolean 3-lattice in Figure 3.1

1. We conclude  $S'(1_{G'}) = \bigcup_{\varphi(b) \leq' 1_{G'}} S(b) \supseteq S(1_G) = M$ .
2. The inclusion " $\subseteq$ " is valid because of the monotonicity of  $S'$ . For the converse inclusion consider  $x \in S'(a) \cap S'(b)$ . There exist  $c, d \in G$  such that  $\varphi(c) \leq' a$ ,  $\varphi(d) \leq' b$ ,  $x \in S(c)$ , and  $x \in S(d)$ . We obtain  $\varphi(c \wedge d) \leq' \varphi(c) \wedge' \varphi(d) \leq' a \wedge' b$  and  $x \in S(c) \cap S(d) = S(c \wedge d)$ , and consequently  $x \in S'(a \wedge' b)$ .
3. For  $a \in G$  and  $x \in T_S(a)$  we obtain  $x \in S(a) \subseteq S'(\varphi(a))$ . Assume that  $x \notin T_{S'}(\varphi(a))$ . Then there exists a  $c <' \varphi(a)$  such that  $x \in S'(c)$ . Consequently, there exists a  $b \in G$  such that  $\varphi(b) \leq' c$  and  $x \in S(b)$ . Hence  $x \in S(a) \cap S(b) = S(a \wedge b)$ . Because of  $x \in T_S(a)$  we get  $a \wedge b \not\leq a$  and thus  $a \leq b$ . We conclude  $\varphi(a) \leq' \varphi(b) \leq' c$ , a contradiction.  $\square$

**Example 3.15.** The 3-lattice  $(G, f)$  shown in Figure 3.1 and the 3-lattice  $(G', f')$  shown in Figure 3.3 are equivalent. This can be seen as follows: Define the functions  $\varphi : G \rightarrow G'$  and  $\psi : G' \rightarrow G$  by

$$\begin{aligned} \varphi(111) &= \varphi(121) = \varphi(211) = a, \\ \varphi(112) &= \varphi(221) = b, \\ \varphi(122) &= \varphi(212) = \varphi(222) = c, \end{aligned}$$

and

$$\psi(a) = 111, \quad \psi(b) = 112, \quad \text{and } \psi(c) = 222.$$

It is easy to see that  $\varphi$  and  $\psi$  are monotonic,  $f(x) = f'(\varphi(x))$  for all  $x \in G$ , and  $f'(x) = f(\psi(x))$  for all  $x \in G'$ . By the Embedding Lemma we obtain  $\mathcal{K}(G, f) = \mathcal{K}(G', f')$  for all  $\mathcal{K}$ . Obviously,

$$\mathcal{K}(G', f') = \{ (\overline{B}, A, B \setminus A) \mid A, B \in \mathcal{K} \text{ and } A \subseteq B \} = (\text{co}\mathcal{K}, \mathcal{K}, \cdot) = (\text{co}\mathcal{K}, \mathcal{K}, \mathcal{K}(2)).$$

Now we are able to prove Theorem 3.11 from Section 3.2.

*Proof.* (Theorem 3.11) Let  $(G, f)$  be an arbitrary  $k$ -lattice, let  $I$  be the set of meet-irreducible elements of  $G$ , and let

$$I_a =_{\text{def}} \{ b \mid b \geq a \text{ and } b \text{ meet-irreducible} \}$$

for every  $a \in G$ . It is well known (cf. [Grä78]) that  $\bigwedge I_a = a$  for every  $a \in G$ . We define the boolean  $k$ -lattice  $((\mathcal{P}(I), \supseteq), h)$  by

$$h(U) =_{\text{def}} f\left(\bigwedge U\right) \quad \text{for } U \subseteq I.$$

The function  $\varphi : G \rightarrow \mathcal{P}(I)$  defined by  $\varphi(a) =_{\text{def}} I_a$  is monotonic, and we get

$$h(\varphi(a)) = h(I_a) = f(\bigwedge I_a) = f(a).$$

By the Embedding Lemma we obtain  $\mathcal{K}(G, f) \subseteq \mathcal{K}((\mathcal{P}(I), \supseteq), h)$ . On the other hand, the function  $\psi : \mathcal{P}(I) \rightarrow G$  defined by  $\psi(U) =_{\text{def}} \bigwedge U$  is monotonic, and we get

$$f(\psi(U)) = f(\bigwedge U) = h(U).$$

Again by the Embedding Lemma we obtain  $\mathcal{K}((\mathcal{P}(I), \supseteq), h) \subseteq \mathcal{K}(G, f)$ . So we get  $\mathcal{K}(G, f) = \mathcal{K}((\mathcal{P}(I), \supseteq), h)$ , but  $(\mathcal{P}(I), \supseteq)$  and  $(\{1, 2\}^{|I|}, \leq)$  are isomorphic.  $\square$

Combining this proof of Theorem 3.11 and the Embedding Lemma one can generalize Theorem 3.4 to the following theorem.

**Theorem 3.16.**  $\mathcal{K}(G, f) = \text{co}\mathcal{K}(G^\partial, f)$  for all  $k$ -lattices  $(G, f)$  with  $k \geq 2$ .

*Proof.* Let  $(G, f)$  be any  $k$ -lattice. By Theorem 3.11 there is a function  $f' : \{1, 2\}^m \rightarrow \{1, 2, \dots, k\}$  with  $\mathcal{K}(G, f) = \mathcal{K}(f')$ . In fact, the proof of Theorem 3.11 shows that  $(G, f) \equiv (\{1, 2\}^m, f')$ . Regarding the dual function  $f'^\partial$  we obtain that  $(G^\partial, f) \equiv (\{1, 2\}^m, f'^\partial)$ . By Theorem 3.4 and the Embedding Lemma,  $\mathcal{K}(G, f) = \mathcal{K}(f') = \text{co}\mathcal{K}(f'^\partial) = \text{co}\mathcal{K}(G^\partial, f)$ .  $\square$

### 3.4 Minimal Descriptions of Partition Classes

From Proposition 3.10 and Theorem 3.11 we know that the boolean hierarchy of  $k$ -partitions is precisely the family of all partition classes over  $\mathcal{K}$  generated by  $k$ -lattices. The advantage of this characterization is that  $k$ -lattices allow often smaller descriptions of partition classes than functions (as shown by Example 3.15). The usage of labeled lattices provides also another advantage over functions: The minimal representations of partition classes using  $k$ -lattices are essentially unique, i.e., unique *up to isomorphy*.

**Definition 3.17.** For  $k$ -posets  $(G, f)$  and  $(G', f')$  we write  $(G, f) \cong (G', f')$  and we say that  $(G, f)$  and  $(G', f')$  are *isomorphic* if there exists a bijective function  $\varphi : G \rightarrow G'$  such that  $\varphi$  and  $\varphi^{-1}$  are monotonic and  $f'(\varphi(a)) = f(a)$  for every  $a \in G$ .

Obviously, isomorphic  $k$ -lattices are equivalent, but there are equivalent  $k$ -lattices which are not isomorphic. For example, add to any  $k$ -lattice  $(G, f)$  a new element  $a$  which is less than all elements of  $G$ , and define  $f(a) = f(0_G)$ . The new  $k$ -lattice is equivalent but not isomorphic to  $(G, f)$ .

**Definition 3.18.** A finite  $k$ -lattice ( $k$ -poset)  $(G, f)$  is said to be *minimal* if there does not exist a  $k$ -lattice ( $k$ -poset, resp.)  $(G', f')$  such that  $(G, f) \equiv (G', f')$  and  $\|G'\| < \|G\|$ .

In this section we will prove that equivalent minimal  $k$ -lattices are isomorphic. This is a basic difference between  $k$ -lattices and  $k$ -valued functions (boolean  $k$ -lattices). Say that a function  $f : \{1, 2\}^m \rightarrow \{1, 2, \dots, k\}$  is minimal if there is no function of arity less than that of  $f$ , such that the corresponding boolean  $k$ -lattices are equivalent. The simple example in Figure 3.4 shows that minimal equivalent functions (boolean  $k$ -lattices) need not be isomorphic.

In order to prove our isomorphy theorem it seems to be easier to show this first for the case of posets.

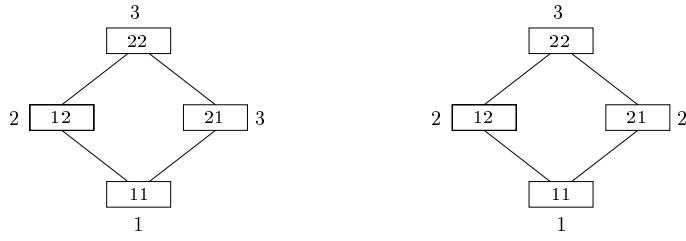

Fig. 3.4. Non-isomorphic minimal equivalent boolean 3-lattices

**Lemma 3.19.** *Let  $(G, f)$  be a minimal  $k$ -poset, and let  $\varphi : G \rightarrow G$  be a monotonic function such that  $f(\varphi(a)) = f(a)$  for all  $a \in G$ . Then there exists an  $m \geq 1$  with  $\varphi^m = \text{id}_G$ .*

*Proof.* For every  $a \in G$  let  $i_a$  be the smallest number such that there exists a  $j > i_a$  with  $\varphi^{i_a}(a) = \varphi^j(a)$ , and let  $j_a$  be the smallest such  $j$ . Obviously,

$$\varphi^{i_a}(\{a, \varphi(a), \varphi^2(a), \dots, \varphi^{j_a-1}(a)\}) = \{\varphi^{i_a}(a), \varphi^{i_a+1}(a), \dots, \varphi^{j_a-1}(a)\}.$$

Note that the set  $\{a, \varphi(a), \varphi^2(a), \dots, \varphi^{j_a-1}(a)\}$  has exactly  $j_a$  elements and that the set  $\{\varphi^{i_a}(a), \varphi^{i_a+1}(a), \dots, \varphi^{j_a-1}(a)\}$  has exactly  $j_a - i_a$  elements. Now assume  $i_a > 0$ . Then  $\|\varphi^{i_a}(G)\| < \|G\|$  and  $(\varphi^{i_a}(G), f) \equiv (G, f)$  which contradicts the minimality of  $(G, f)$ . Hence  $i_a = 0$  and  $\varphi^{j_a}(a) = a$ . Now let  $m = \prod_{a \in G} j_a$  and get  $\varphi^m = \text{id}_G$ .  $\square$

**Lemma 3.20.** *Equivalent minimal  $k$ -posets are isomorphic.*

*Proof.* Let  $(G, f)$  and  $(G', f')$  be equivalent minimal  $k$ -posets. There exist monotonic functions  $\varphi : G \rightarrow G'$  and  $\psi : G' \rightarrow G$  such that  $f'(\varphi(a)) = f(a)$  for all  $a \in G$  and  $f(\psi(a)) = f'(a)$  for all  $a \in G'$ . Hence  $\psi \circ \varphi$  is monotonic and  $f(\psi(\varphi(a))) = f(a)$  for all  $a \in G$ . By Lemma 3.19 there exists an  $m \geq 1$  such that  $(\psi \circ \varphi)^m = \text{id}_G$ . Also  $\varphi \circ \psi$  is monotonic and  $f'(\varphi(\psi(a))) = f'(a)$  for all  $a \in G'$ , and there exists an  $n \geq 1$  such that  $(\varphi \circ \psi)^n = \text{id}_{G'}$ . Hence,  $\psi \circ (\varphi \circ (\psi \circ \varphi)^{mn-1}) = \text{id}_G$ ,  $(\varphi \circ (\psi \circ \varphi)^{mn-1}) \circ \psi = \text{id}_{G'}$ ,  $\varphi \circ (\psi \circ \varphi)^{mn-1} : G \rightarrow G'$  is monotonic,  $\psi : G' \rightarrow G$  is monotonic, and  $f'(\varphi \circ (\psi \circ \varphi)^{mn-1}(a)) = f(a)$  for all  $a \in G$ . Thus  $(G, f) \cong (G', f')$ .  $\square$

**Lemma 3.21.** *A minimal  $k$ -poset, which is equivalent to a  $k$ -lattice, is a  $k$ -lattice.*

*Proof.* Let  $(G, f)$  be a minimal  $k$ -poset, and let  $(G', f')$  be a  $k$ -lattice such that  $(G, f) \equiv (G', f')$  via  $\varphi : G \rightarrow G'$  and  $\psi : G' \rightarrow G$ . By Lemma 3.19 there exists an  $m \geq 1$  such that  $(\psi \circ \varphi)^m = \text{id}_G$ . We define

$$\xi =_{\text{def}} \varphi \circ (\psi \circ \varphi)^{m-1}.$$

Then we obtain  $\psi \circ \xi = \text{id}_G$ . To prove that  $G$  is a lattice it suffices to verify that

1.  $G$  has a supremum  $1_G$ ,
2.  $a \wedge b$  exists for all  $a, b \in G$ .

This can be done as follows:

1. For  $a \in G$  we get  $\xi(a) \leq 1_{G'}$  and hence  $a = \psi(\xi(a)) \leq \psi(1_{G'})$ . Consequently,  $1_G = \psi(1_{G'})$ .

2. For  $a, b, c \in G$  such that  $c \leq a, b$  we get  $\xi(c) \leq \xi(a), \xi(b)$  and hence  $\xi(c) \leq \xi(a \wedge b) \leq \xi(a), \xi(b)$ . Consequently,  $c = \psi(\xi(c)) \leq \psi(\xi(a) \wedge \xi(b)) \leq \psi(\xi(a)) = a, \psi(\xi(b)) = b$ . That means  $a \wedge b = \psi(\xi(a) \wedge \xi(b))$ . □

From the preceding two lemmas we obtain immediately:

**Theorem 3.22.** *Equivalent minimal  $k$ -lattices are isomorphic. In other words, for every  $k$ -lattice there exists a (up to isomorphy) unique minimal equivalent  $k$ -lattice.*

This theorem ensures that we can always choose a unique starting point for investigations involving classes of boolean hierarchy of  $k$ -partitions. Moreover, when restricting to the minimal  $k$ -lattices our relation  $\leq$  becomes a partial order (however, this is merely a fact based on the selection of the minimal  $k$ -lattices as representatives of the equivalence classes with respect to  $\leq$ ).

### 3.5 The Embedding Conjecture

Let us come back to the Embedding Lemma which shows that  $(G, f) \leq (G', f')$  implies  $\mathcal{K}(G, f) \subseteq \mathcal{K}(G', f')$ . Thus we have a sufficient criterion for inclusion of partition classes. It would be, however, very useful if the criterion would be also necessary. In this section we pose the conjecture that this holds true for NP unless the polynomial hierarchy is finite. We suppose this conjecture with several results.

#### 3.5.1 On Inverting the Embedding Lemma

We are interested in proving the following theorem for the case  $\mathcal{K} = \text{NP}$ . Note that for the general formulation  $\mathcal{K}$  is assumed to be such that  $\emptyset, M \in \mathcal{K}$  and  $\mathcal{K}$  is closed under intersection and union.

**Embedding Theorem for  $\mathcal{K}$ .** *Let  $(G, f)$  and  $(G', f')$  be  $k$ -lattices. Then,  $(G, f) \leq (G', f')$  if and only if  $\mathcal{K}(G, f) \subseteq \mathcal{K}(G', f')$ .*

The difficult part of the theorem is the inversion of the Embedding Lemma, that is, the direction from right to left. If once proven for a class  $\mathcal{K}$  the Embedding Theorem gives the complete information about  $\text{BH}_k(\mathcal{K})$ . The following theorem shows that Embedding Theorems are in principle not out of reach:<sup>1</sup>

**Theorem 3.23.** *Let  $(G, f)$  and  $(G', f')$  be  $k$ -lattices with  $k \geq 2$ . If  $\mathcal{K}(G, f) \subseteq \mathcal{K}(G', f')$  for every class  $\mathcal{K}$  with  $\emptyset, M \in \mathcal{K}$  and which is closed under intersection and union, then  $(G, f) \leq (G', f')$ .*

*Proof.* Let  $(G, f)$  and  $(G', f')$  be  $k$ -lattices. For each set  $S \subseteq G$ , define  $D(S)$  as

$$D(S) =_{\text{def}} \{ a \in G \mid (\exists b \in S)[a \leq b] \}.$$

<sup>1</sup> Note that the negative statement of Theorem 3.23 would imply that for every reasonable  $\mathcal{K}$ , there exists a pair of  $k$ -lattices that contradicts the Embedding Theorem for  $\mathcal{K}$ .

Let  $\mathcal{K}$  be the set of all  $D(S)$  for  $S \subseteq G$ . Clearly,  $\emptyset, G \in \mathcal{K}$  and  $\mathcal{K}$  is closed under finite union and intersection. Let  $S$  be the  $\mathcal{K}$ -homomorphism on  $G$  defined for every  $a \in G$  as

$$S(a) =_{\text{def}} D(\{a\}).$$

Obviously,  $T_S(a) = \{a\}$  and consequently  $(f^{-1}(1), \dots, f^{-1}(k)) \in \mathcal{K}(G, f) \subseteq \mathcal{K}(G', f')$ . Hence, a  $\mathcal{K}$ -homomorphism  $S' : G' \rightarrow \mathcal{K}$  on  $G'$  exists such that  $\bigcup_{f'(d)=i} T_{S'}(d) = f^{-1}(i)$  for every  $i \in \{1, 2, \dots, k\}$ . Define  $h : G \rightarrow G'$  to be the function which assigns to each  $a \in G$  the uniquely determined  $d \in G'$  such that  $a \in T_{S'}(d)$ , i.e.,  $h^{-1}(d) = T_{S'}(d)$ . Obviously,  $a \in T_{S'}(h(a))$  and  $f'(h(a)) = f(a)$ . It remains to show that  $h$  is monotonic. Let  $a, b \in G$  with  $a \leq b$ . Then  $b \in T_{S'}(h(b)) \subseteq S'(h(b))$ , so  $a \in S'(h(b))$ . From Lemma 3.7.2 there follows the existence of  $c \in G'$  with  $c \leq h(b)$  and  $a \in T_{S'}(c)$ . Thus  $c = h(a)$ , hence  $h(a) \leq h(b)$ .  $\square$

Because of Proposition 3.2.2, we cannot hope to invert the Embedding Lemma without an additional assumption to  $\mathcal{K}$ . A plausible one might be a strict boolean hierarchy of *sets* over  $\mathcal{K}$ . And indeed, for many subclasses of  $k$ -lattices, assuming the strictness of  $\text{BH}_2(\mathcal{K})$  is strong enough to show the Embedding Theorem for  $\mathcal{K}$  and for these subclasses of labeled lattices.

For instance, we can prove that the Embedding Theorem for 2-lattices holds if we assume an infinite  $\text{BH}_2(\mathcal{K})$ . To this end we first prove an analogue to Theorem 2.2 for 2-lattices. For a 2-lattice  $(G, f)$  let  $\mu(G, f)$  be the maximum number of alternations of  $f$ -labels which can occur in a  $\leq$ -chain in the lattice  $G$ .

**Theorem 3.24.** *For every 2-lattice  $(G, f)$ ,*

$$\mathcal{K}(G, f) = \begin{cases} \mathcal{K}(\mu(G, f)) & \text{if } f(1_G) = 2, \\ \text{co}\mathcal{K}(\mu(G, f)) & \text{if } f(1_G) = 1. \end{cases}$$

*Proof.* Let  $(G, f)$  be a 2-lattice. In the proof of Theorem 3.11 we defined a function  $h : \{1, 2\}^{|I|} \rightarrow \{1, 2\}$  (remember that  $I$  is the set of meet-irreducible elements of  $G$  and that  $(\mathcal{P}(I), \supseteq)$  and  $(\{1, 2\}^{|I|}, \leq)$  are isomorphic) such that  $(G, f) \equiv (\{1, 2\}^{|I|}, h)$ . Consequently,  $\mathcal{K}(G, f) = \mathcal{K}(\{1, 2\}^{|I|}, h) = \mathcal{K}(h)$ ,  $\mu(G, f) = \mu(\{1, 2\}^{|I|}, h) = \mu(h)$ , and  $f(1_G) = h(2^{|I|})$ . By Theorem 2.2 we obtain the statement.  $\square$

**Corollary 3.25.** *Assume that  $\text{BH}_2(\mathcal{K})$  is infinite.*

1. *The minimal 2-lattice  $(G, f)$  such that  $\mathcal{K}(G, f) = \mathcal{K}(i)$  is a chain with  $i + 1$  elements with alternating labels 1 and 2 such that the maximum of the chain has label 2.*
2. *The minimal 2-lattice  $(G, f)$  such that  $\mathcal{K}(G, f) = \text{co}\mathcal{K}(i)$  is a chain with  $i + 1$  elements with alternating labels 1 and 2 such that the maximum of the chain has label 1.*

As a consequence of Theorem 3.24 we get the validity of the (conditional) Embedding Theorem for 2-lattices.

**Theorem 3.26.** *Assume that  $\text{BH}_2(\mathcal{K})$  is infinite. For 2-lattices  $(G, f)$  and  $(G', f')$  the following statements are equivalent:*

1.  $\mathcal{K}(G, f) \subseteq \mathcal{K}(G', f')$ .
2.  $\mu(G, f) < \mu(G', f')$  or  $(\mu(G, f) = \mu(G', f')$  and  $f(1_G) = f'(1_{G'})$ ).
3.  $(G, f) \leq (G', f')$ .



*Proof.*

- (1)  $\Rightarrow$  (2) is a consequence of Theorem 3.24.
- (3)  $\Rightarrow$  (1) follows from the Embedding Lemma.
- For (2)  $\Rightarrow$  (3) take a  $\leq$ -chain  $(c_0, c_1, \dots, c_r)$  in  $G'$  with maximum number of alternations between  $f'$ -labels, i.e.,  $r = \mu(G', f')$  and  $f'(c_{i-1}) \neq f'(c_i)$  for  $i \in \{1, \dots, r\}$ . For  $a \in G$  define  $\varphi(a)$  as follows:

$$\varphi(a) =_{\text{def}} \begin{cases} c_i & \text{if } f(1_G) = f'(1_{G'}), \\ c_{i+1} & \text{if } f(1_G) \neq f'(1_{G'}). \end{cases}$$

Here  $i$  is the maximum number of alternations between  $f$ -labels in a chain from  $a$  to  $1_G$ . Obviously,  $\varphi$  is monotonic and  $f'(\varphi(a)) = f(a)$ . □

We now establish a theorem which shows that the Embedding Theorem for  $\mathcal{K}$  holds for a large subclass of  $k$ -lattices (unless  $\text{BH}_2(\mathcal{K})$  is finite). At this, we make use of the following simple principle.

**Proposition 3.27.** *Let  $(G, f)$  and  $(G', f')$  be  $k$ -lattices with  $k \geq 2$ . Let  $h$  be a function mapping  $\{1, 2, \dots, k\}$  to  $\{1, 2, \dots, m\}$ . If  $\mathcal{K}(G, f) \subseteq \mathcal{K}(G', f')$ , then  $\mathcal{K}(G, h \circ f) \subseteq \mathcal{K}(G', h \circ f')$ . Moreover, if  $h$  is injective, then the equivalence holds.*

Let  $(G, f)$  be a  $k$ -lattice. For  $I, J \subseteq \{1, 2, \dots, k\}$  with  $I \cap J = \emptyset$ , define  $\mu_{I,J}(G, f)$  to be the maximum number of alternations between  $f$ -labels from  $I$  and  $f$ -labels from  $J$  in a chain of  $G$  whose minimum has an  $f$ -label from  $I$ .

**Theorem 3.28.** *Assume  $\text{BH}_2(\mathcal{K})$  is infinite. For  $k$ -lattices  $(G, f)$  and  $(G', f')$ , if  $\mathcal{K}(G, f) \subseteq \mathcal{K}(G', f')$ , then  $\mu_{I,J}(G, f) \leq \mu_{I,J}(G', f')$  for all  $I, J \subseteq \{1, 2, \dots, k\}$  with  $I \cap J = \emptyset$ .*

*Proof.* If  $I = \emptyset$  or  $J = \emptyset$ , then  $\mu_{I,J}(G, f) = 0$  for all  $(G, f)$ . So, suppose  $I$  and  $J$  to be non-empty and  $I \cap J = \emptyset$ . Consider the function  $h$  mapping elements from  $I$  to  $\min I$ , elements from  $J$  to  $\min J$ , and elements not in  $I$  or  $J$  to themselves. Then, for all  $k$ -lattices  $(G, f)$ , it holds  $\mu_{I,J}(G, f) = \mu_{h(I), h(J)}(G, h \circ f)$ . Therefore and because of Proposition 3.27, without loss of generality, we can assume that  $I$  and  $J$  are singletons;  $I = \{i\}$ ,  $J = \{j\}$ , and  $i \neq j$ . For convenience, we write  $\mu_{ij}(G, f)$  instead of  $\mu_{\{i\}, \{j\}}(G, f)$ .

Let  $(G, f)$  and  $(G', f')$  be  $k$ -lattices. Let  $C$  be a maximal chain in  $G$  such that  $\mu_{ij}(C, f|_C) = \mu_{ij}(G, f)$ . Hence,  $\mathcal{K}(C, f|_C) \subseteq \mathcal{K}(G', f')$ . Since  $f|_C : C \rightarrow \{i, j\}$  we have also  $\mathcal{K}(C, f|_C) \subseteq \mathcal{K}(G', h)$  for all  $h : G' \rightarrow \{1, 2, \dots, k\}$  such that  $h(a) = f'(a)$  if  $f'(a) \in \{i, j\}$ .

If there is no  $b \in G'$  with  $f'(b) \notin \{i, j\}$ , then the claim is just the same already proven in Theorem 3.26. So, fix some  $b \in G'$  such that  $f'(b) \notin \{i, j\}$ . For each  $a \in G'$ , let  $G'_a$  be the set  $\{c \in G' \mid c \leq a\}$ . Define for  $a \in G'$

$$h(a) =_{\text{def}} \begin{cases} f'(a) & \text{if } a \neq b, \\ i & \text{if } a = b \text{ and } \mu_{ij}(G'_b, f'|_{G'_b}) \text{ is even,} \\ j & \text{if } a = b \text{ and } \mu_{ij}(G'_b, f'|_{G'_b}) \text{ is odd.} \end{cases}$$

Hence,  $\mathcal{K}(C, f|_C) \subseteq \mathcal{K}(G', h)$  and  $\mu_{ij}(G', f') \leq \mu_{ij}(G', h)$ . Consider a maximal chain  $a_0 < a_1 < \dots < a_r$  in  $G'$  such that  $r = \mu_{ij}(G', h)$ ,  $h(a_s) \in \{i, j\}$ ,  $h(a_0) = i$ , and  $h(a_{s-1}) \neq$

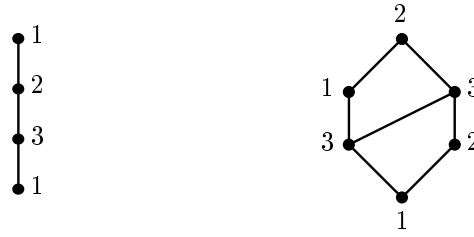

Fig. 3.5. The 3-lattices of Example 3.29

$h(a_s)$  for  $s \in \{1, \dots, r\}$ . If  $b \notin \{a_0, \dots, a_r\}$  then  $h(a_s) = f'(a_s)$  for all  $s = \{0, 1, \dots, r\}$  and hence  $\mu_{ij}(G', f') \geq \mu_{ij}(G', h)$ , thus  $\mu_{ij}(G', f') = \mu_{ij}(G', h)$ . Now let  $b = a_s$  for some  $s \in \{0, 1, \dots, r\}$ . Since  $f'(a_{s-1}) = h(a_{s-1}) \neq h(a_s)$  and, by definition,  $h(b) = h(a_s)$ , the chain  $a_0 < a_1 < \dots < a_{s-1}$  cannot be a maximum chain in  $G'_b$  with alternating  $f'$ -labels starting with  $f'$ -label  $i$ . Hence there exists such a chain  $b_0 < b_1 < \dots < b_{s-1} < b_s$  in  $(G'_b, f'|_{G'_b})$  and consequently such a chain  $b_0 < b_1 < \dots < b_{s-1} < b_s < a_{s+1} < \dots < a_r$  in  $(G', f')$ . This means  $\mu_{ij}(G', f') \geq r = \mu_{ij}(G', h)$  and hence,  $\mu_{ij}(G', f') = \mu_{ij}(G', h)$ .

Repeating this construction we obtain finally a function  $g : G' \rightarrow \{i, j\}$  such that  $\mathcal{K}(C, f|_C) \subseteq \mathcal{K}(G', g)$ ,  $\mu_{ij}(C, f|_C) = \mu_{ij}(G, f)$ , and  $\mu_{ij}(G', g) = \mu_{ij}(G', f')$ . In fact,  $\mathcal{K}(C, f|_C)$  and  $\mathcal{K}(G', g)$  are classes of 2-partitions. By Theorem 3.26, we obtain  $\mu(C, f|_C) < \mu(G', g)$  or,  $\mu(C, f|_C) = \mu(G', g)$  and  $f(1_C) = g(1_{G'})$ , from which we can conclude  $\mu_{ij}(C, f|_C) \leq \mu_{ij}(G', g)$ .  $\square$

**Example 3.29.** Let  $(G, f)$  be the 3-lattice on the left-hand side and  $(G', f')$  be the 3-lattice on the right-hand side of Figure 3.5. To show  $\mathcal{K}(G, f) \not\subseteq \mathcal{K}(G', f')$  if  $\text{BH}_2(\mathcal{K})$  is infinite, let  $I = \{1\}$  and  $J = \{2\}$ . Then we have  $\mu_{I,J}(G, f) = 2$  and  $\mu_{I,J}(G', f') = 1$ . Hence, by Theorem 3.28,  $\mathcal{K}(G, f) \not\subseteq \mathcal{K}(G', f')$  unless  $\text{BH}_2(\mathcal{K})$  is finite. Reversely, let  $I = \{1\}$  and  $J = \{2, 3\}$ . Then,  $\mu_{I,J}(G', f') = 3$  and  $\mu_{I,J}(G, f) = 2$ . Thus, again by Theorem 3.28,  $\mathcal{K}(G', f') \not\subseteq \mathcal{K}(G, f)$  unless  $\text{BH}_2(\mathcal{K})$  is finite.

Theorem 3.26 and Theorem 3.28 suggest that a strict boolean hierarchy of sets is sufficient to establish Embedding Theorems. However, there are classes for which the Embedding Theorem does not hold though they have a strict boolean hierarchy. A very prominent example is the class RE of the recursively enumerable sets. Clearly, the enumerable sets are closed under intersection and union and contain  $\emptyset$  and  $\Sigma^*$ . The strictness of the boolean hierarchy of the recursively enumerable sets goes back to Ershov [Ers68a].

**Theorem 3.30.** *The Embedding Theorem for RE does not hold.*

*Proof.* Let  $(G, f)$  be the left 3-lattice and  $(G', f')$  be the right 3-lattice in Figure 3.6. Obviously,  $(G, f) \not\subseteq (G', f')$ . However, it holds that  $\text{RE}(G, f) \subseteq \text{RE}(G', f')$ . To prove this we first show the following claim.

**Claim.** For all sets  $A, B \in \text{RE}$  there are sets  $C, D \in \text{RE}$  such that the following conditions are satisfied:

1.  $C \cup D = A \cup B$ ,
2.  $C \cap D = \emptyset$ ,

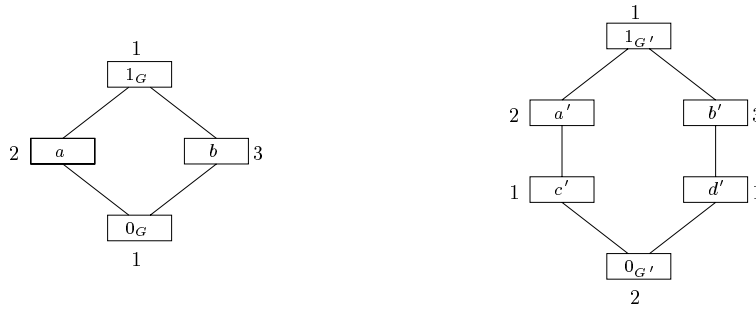

**Fig. 3.6.** The 3-lattices critical for RE

3.  $C \subseteq A$ ,
4.  $D \subseteq B$ .

*Proof of the Claim.* Recall that there exist sets  $R_A$  and  $R_B$  in REC such that for all  $x \in \Sigma^*$ ,

$$\begin{aligned} x \in A &\iff \text{there exists an } y \text{ with } (x, y) \in R_A, \\ x \in B &\iff \text{there exists an } y \text{ with } (x, y) \in R_B. \end{aligned}$$

Define a function  $f$  as

$$f(x) =_{\text{def}} \begin{cases} \min\{y \mid (x, y) \in R_A \cup R_B\} & \text{if there is an } y \text{ such that } (x, y) \in R_A \cup R_B, \\ \text{not defined} & \text{otherwise.} \end{cases}$$

It is easily seen that  $f$  is computable and  $D_f = A \cup B$ . Define the sets  $C$  and  $D$  as

$$\begin{aligned} C &=_{\text{def}} \{x \in \Sigma^* \mid f(x) \text{ is defined and } (x, f(x)) \in R_A\}, \\ D &=_{\text{def}} \{x \in \Sigma^* \mid f(x) \text{ is defined and } (x, f(x)) \notin R_A\}. \end{aligned}$$

Then  $C, D \in \text{RE}$  and it holds that

1.  $C \cup D = D_f = A \cup B$ ,
2.  $C \cap D = \emptyset$ ,
3.  $C \subseteq A$  (this can be seen as follows: if  $x \in C$ , then  $(x, f(x)) \in R_A$ , hence  $x \in A$ ),
4.  $D \subseteq B$  (this can be seen as follows: if  $x \notin D$ , then  $(x, f(x)) \notin R_A$ , thus  $(x, f(x)) \in R_B$ , and consequently,  $x \in B$ ).

This proves the claim.

Now let  $(G, f, S) \in \text{RE}(G, f)$ . By the claim above there are sets  $C, D \in \text{RE}$  with  $C \cup D = S(a) \cup S(b)$ ,  $C \cap D = \emptyset$ ,  $C \subseteq S(a)$ , and  $D \subseteq S(b)$ . Since a RE-homomorphism on lattices only depends on its values on the meet-irreducible elements, it is enough to define  $S'$  on  $G'$  as

$$\begin{aligned} S'(a') &=_{\text{def}} C, \\ S'(b') &=_{\text{def}} D, \\ S'(c') &=_{\text{def}} C \cap S(b), \\ S'(d') &=_{\text{def}} D \cap S(a). \end{aligned}$$

Clearly, it holds that  $S'(c') \subseteq S'(a')$ ,  $S'(d') \subseteq S'(b')$ , and  $S'(a') \cap S'(b') = \emptyset = S'(c') \cap S'(d')$ . Moreover we have the following:

$$\begin{aligned} (G', f', S')_2 &= T_{S'}(a') \cup T_{S'}(0_{G'}) = T_{S'}(a') = S'(a') \setminus S'(c') = C \setminus (C \cap S(b)) \\ &= (C \cup S(b)) \setminus S(b) = (S(a) \cup S(b)) \setminus S(b) = S(a) \setminus (S(a) \cap S(b)) \\ &= S(a) \setminus S(0_G) = T_S(a) = (G, f, S)_2 \end{aligned}$$

The remaining equalities can be shown similar to the equality of the second component. This gives  $(G, f, S) = (G', f', S')$ . Hence,  $(G, f, S) \in \text{RE}(G', f')$ .  $\square$

Up to this theorem, all results so far hold for arbitrary classes with some simple closure properties. The forthcoming now makes use of the very nature of the class NP. As we have seen even an infinite boolean hierarchy of sets is not sufficient to invert the Embedding Lemma. Since the collapse of the boolean hierarchy over NP implies the collapse of the polynomial hierarchy (cf. [Kad88]) the following conjecture seems to be reasonable.

**Embedding Conjecture.** *Assume the polynomial hierarchy is infinite. Let  $(G, f)$  and  $(G', f')$  be  $k$ -lattices. Then  $\text{NP}(G, f) \subseteq \text{NP}(G', f')$  if and only if  $(G, f) \leq (G', f')$ .*

To provide evidence for the Embedding Conjecture we formulate in Subsection 3.5.2 a theorem (Theorem 3.47) which shows that the conjecture is true for a much larger subclass of  $k$ -lattices than touched by Theorem 3.28 including all 2-lattices (Corollary 3.46) and moreover, all  $k$ -chains (Theorem 3.44). Furthermore, the 3-lattices in Figure 3.6 turn out to be no counterexample for the class NP. This is proven in Subsection 3.5.3.

Still more evidence will come from the relativized Embedding Theorem (Theorem 4.42) which we will show in Section 4.4 in a more general setting. As a corollary (Corollary 4.43) from this theorem we obtain that for  $k$ -lattices  $(G, f)$  and  $(G', f')$ ,  $(G, f) \leq (G', f')$  if and only if  $\text{NP}(G, f)$  is *relativizably* contained in  $\text{NP}(G', f')$ . Note that if we would have proven the Embedding Conjecture using relativizable proof techniques (what should be true if we can prove the conjecture at all), then we would have a much stronger theorem than this relativized Embedding Theorem since it is known that there exists an oracle which makes the polynomial hierarchy infinite.

### 3.5.2 Evidence I: The Case of $k$ -Chains

We establish theorems that show that the Embedding Conjecture is true for a very large subclass of  $k$ -lattices based on differences in the chain structure of the lattices. In Theorem 3.28 differences concerning the mind changes in  $k$ -chains are considered. However, the theorem is not general enough to cover all  $k$ -chains. As an example consider the two 3-chains in Figure 3.7. Let  $(G, f)$  be the left and  $(G', f')$  be the right 3-chain. On the one hand, it is easy to calculate that  $\mu_{I,J}(G, f) = \mu_{I,J}(G', f')$  for all  $I, J \subseteq \{1, 2, 3\}$  with  $I \cap J = \emptyset$ . On the other hand, obviously  $(G, f) \not\leq (G', f')$  and  $(G', f') \not\leq (G, f)$ . So in order to support the Embedding Conjecture we have to prove that  $\text{NP}(G, f) \not\subseteq \text{NP}(G', f')$  as well as  $\text{NP}(G', f') \not\subseteq \text{NP}(G, f)$  unless the polynomial hierarchy is finite. In this subsection we will see how to do this. Proving such theorems, we detect some normal forms of (hypothetical) inclusions between partition classes enabling us a generalization of the easy-hard arguments developed by Kadin (cf. [Kad88]) to the context of partition classes.

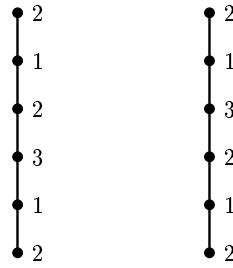

Fig. 3.7. Counterexample to the mind-change technique

**Partition Classes Defined by Chains.** We first emphasize some simplifications and peculiarities of partition classes over labeled chains. As long as possible we consider general classes  $\mathcal{K}$  with  $\emptyset, M \in \mathcal{K}$  and that are closed under intersection and finite union. Partition classes over labeled chains are characterized by ascending chains of sets from  $\mathcal{K}$ .

We identify a  $k$ -chain  $(G, f)$  in a natural way with a word in  $\{1, 2, \dots, k\}^{|G|}$ , namely with  $f(a_1)f(a_2)\dots f(a_n)$  when  $a_1 < a_2 < \dots < a_n$ ,  $a_i \in G$ , and  $n = \|G\|$ . Words representing  $k$ -chains are called  $k$ -words.

The relation  $\leq$  over  $k$ -lattices translates to a subword relation between  $k$ -words. For that, we say that a  $k$ -word  $a$  is *repetition-free* if and only if  $a_i \neq a_{i+1}$  for all  $1 \leq i < n$ . For an arbitrary  $k$ -word  $a$  its repetition-free version  $a_*$  is the word emerging from  $a$  when recursively replacing each occurrence of  $ss$  to  $s$  with  $s \in \{1, 2, \dots, k\}$ . Now, we can say that  $a \preceq b$  for  $k$ -words  $a, b$  if and only if  $a_*$  is a subword of  $b$ . We say  $a \equiv b$  whenever  $a \preceq b$  and  $b \preceq a$ . If  $a$  and  $b$  are repetition-free  $k$ -words then  $a \equiv b$  is equivalent to  $a = b$ . Obviously, the relation  $\preceq$  for  $k$ -words corresponds with the relation  $\leq$  for  $k$ -chains. Repetition-free  $k$ -words correspond to minimal  $k$ -chains. Dual  $k$ -chains correspond to reverse words.

There are some notations caused by our identification. Let a  $k$ -word  $a$  be given. Then a  $\mathcal{K}$ -homomorphism  $S$  on  $a$  is just a  $\mathcal{K}$ -homomorphism on  $(\{1, 2, \dots, |a|\}, a)$ , the partition  $(a, S)$  generated by  $S$  is the partition  $(\{1, 2, \dots, |a|\}, a, S)$ , and, finally,  $\mathcal{K}(a) = \mathcal{K}(\{1, 2, \dots, |a|\}, a)$ . Here we have identified the  $k$ -word  $a$  with the function  $a : \{1, 2, \dots, |a|\} \rightarrow \{1, 2, \dots, k\}$  given by  $a(i) = a_i$ .

If two  $k$ -words are comparable with respect to  $\preceq$ , there are possibly many monotonic mappings witnessing the relation. This ambiguity is often disadvantageous. So we consider the canonical embedding, mapping every letter of a  $k$ -word to the least possible letter in the other  $k$ -word.

**Definition 3.31.** Let  $a$  and  $a'$  be  $k$ -words,  $k \geq 1$ . The *canonical embedding*  $\kappa[a, a']$  of  $a$  into  $a'$  is a mapping from  $\{0, 1, 2, \dots, |a|\}$  to  $\{0, 1, 2, \dots, |a'|\}$  inductively defined as  $\kappa[a, a'](0) =_{\text{def}} 0$  and for  $j > 0$  as

$$\kappa[a, a'](j) =_{\text{def}} \min\{ r \mid r \geq \kappa[a, a'](j - 1) \wedge a_j = a'_r \}$$

where  $\min \emptyset$  is considered to be undefined.

If there is no reason for misunderstanding, then we omit  $[a, a']$  in the description of the canonical embedding.

**Proposition 3.32.** *Let  $a$  and  $a'$  be  $k$ -words. Then,  $a \preceq a'$  if and only if the canonical embedding  $\kappa$  of  $a$  into  $a'$  is total.*

Canonical embeddings make it possible to determine normal forms for  $\mathcal{K}$ -homomorphisms witnessing inclusions between partition classes.

**Lemma 3.33.** *Let  $a$  and  $a'$  be repetition-free  $k$ -words. Let  $\kappa$  be the canonical embedding of  $a$  into  $a'$ . If  $\mathcal{K}(a) \subseteq \mathcal{K}(a')$ , then for every  $\mathcal{K}$ -homomorphism  $S$  on  $a$  there is a  $\mathcal{K}$ -homomorphism  $S'$  on  $a'$  such that  $(a, S) = (a', S')$  and  $S(j) \subseteq S'(\kappa(j))$  for all  $j \in D_\kappa$ .*

*Proof.* Since  $\mathcal{K}(a) \subseteq \mathcal{K}(a')$ , there is a  $\mathcal{K}$ -homomorphism  $V$  on  $a'$  with  $(a, S) = (a', V)$ . We meet the convention that  $S(0) = \emptyset$  and  $V(0) = \emptyset$ . Define  $S'$  for all  $j \leq |a'|$  as

$$S'(j) =_{\text{def}} V(j) \cup S \left( \max_{\kappa(s) \leq j} s \right).$$

Obviously,  $S'$  is an  $\mathcal{K}$ -homomorphism on  $a'$  with  $S(j) \subseteq S'(\kappa(j))$  for  $j \in D_\kappa$ . It remains to show  $(a, S) = (a', S')$ . We consider the partition  $(a', S')$  individually for every component  $i \in \{1, 2, \dots, k\}$ . Fix a component  $i$ , and consider  $T_{S'}(j)$  for  $j \leq |a'|$  with  $a'_j = i$ . We have two different cases.

- *Case 1.* Suppose  $\kappa(s) < j < \kappa(s+1)$  for an appropriate  $s$ , or  $\kappa(\max D_\kappa) < j$ . Then,

$$\begin{aligned} T_{S'}(j) &= S'(j) \setminus S'(j-1) = (V(j) \cup S(s)) \setminus (V(j-1) \cup S(s)) \\ &= (V(j) \setminus V(j-1)) \setminus S(s) \subseteq T_V(j). \end{aligned}$$

Hence,  $T_{S'}(j) \subseteq T_V(j) \subseteq (a', V)_i = (a, S)_i$ .

- *Case 2.* Suppose  $j = \kappa(s)$  for an appropriate  $s$ . Then,

$$\begin{aligned} T_{S'}(j) &= S'(j) \setminus S'(j-1) = (V(j) \cup S(s)) \setminus (V(j-1) \cup S(s-1)) \\ &= [(V(j) \setminus V(j-1)) \setminus S(s-1)] \cup [(S(s) \setminus S(s-1)) \setminus V(j-1)] \\ &\subseteq T_V(j) \cup T_S(s). \end{aligned}$$

Since  $a_s = a'_{\kappa(s)} = a'_j = i$ , we obtain  $T_{S'}(j) \subseteq T_V(j) \cup T_S(s) \subseteq (a', V)_i \cup (a, S)_i = (a, S)_i$ .

Overall, we have shown  $(a', S')_i \subseteq (a, S)_i$  for every  $i$ . Since  $(a', V)$  and  $(a, S)$  are partitions, we get the equalities  $(a', S')_i = (a, S)_i$ . Thus,  $(a', S') = (a, S)$ .  $\square$

**Hardest Inclusions.** It is our goal to prove the finiteness of the polynomial hierarchy in case of having an inclusion between partition classes which should not be true if the Embedding Conjecture would hold. For the boolean hierarchy  $\text{BH}_2(\text{NP})$  it suffices to consider the inclusion  $\text{NP}(m) \subseteq \text{coNP}(m)$  for  $m \in \mathbb{N}_+$  or, in terms of 2-words,

$$\text{NP}(\underbrace{1212\dots}_{m+1}) \subseteq \text{NP}(\underbrace{2121\dots}_{m+1}).$$

The very simple structure of  $\text{BH}_2(\text{NP})$ , trivially, yields the following: If for any  $m \in \mathbb{N}_+$  there is an  $n < m$  with  $\text{NP}(m) \subseteq \text{NP}(n)$ , or there is an  $l \leq m$  with  $\text{NP}(m) \subseteq \text{coNP}(l)$ , then  $\text{NP}(m) \subseteq \text{coNP}(m)$ . Again, in terms of 2-words, that means: Let  $a$  be a repetition-free 2-word. If for  $a$  there is an  $a'$  with  $a \not\leq a'$  and  $\text{NP}(a) \subseteq \text{NP}(a')$ , then  $\text{NP}(a) \subseteq \text{NP}(\bar{a})$ . Note that for such  $a'$  it holds  $|a'| \leq |a|$ . For  $k$ -words with  $k > 2$  this length condition is not true. For instance, consider  $123$  and  $1(31)^m 2$  for arbitrary  $m \in \mathbb{N}_+$ . Then,  $123 \not\leq 1(31)^m 2$ , but  $|1(31)^m 2|$  can be arbitrarily large. Can we nevertheless identify short  $k$ -words with hardest inclusions to be considered?

In the following we give a positive answer to this question. To do that we need two lemmas.

**Lemma 3.34.**  $\mathcal{K}(a) = \text{co}\mathcal{K}(a^R)$  for all  $k$ -words  $a$ .

*Proof.* Follows from Theorem 3.16.  $\square$

**Lemma 3.35.** Let  $a$  and  $a'$  be repetition-free  $k$ -words,  $k \geq 2$ . Let  $\kappa$  be the canonical embedding of  $a$  into  $a'$ . Let  $r \in D_\kappa$  so that  $a_i \neq a_r$  for all  $i > r$ . If  $\mathcal{K}(a) \subseteq \mathcal{K}(a')$ , then  $\mathcal{K}(a) \subseteq \mathcal{K}(a'')$  where  $a''$  emerges from  $a'$  when deleting  $j$ -th letter of  $a'$  for all  $j > \kappa(r)$  with  $a'_j = a_r$ .

*Proof.* Let  $(a, S) \in \mathcal{K}(a)$  for  $\mathcal{K}$ -homomorphism  $S$  on  $f$ . By Lemma 3.33, there is a  $\mathcal{K}$ -homomorphism  $S'$  on  $a'$  with  $(a, S) = (a', S')$  and  $S(j) \subseteq S'(\kappa(j))$  for all  $j \in D_\kappa$ . It suffices to show  $T_{S'}(j) = \emptyset$  for all  $j > \kappa(r)$  with  $a'_j = a_r$ . Let  $a_r = b$ . Since  $a'_j = a_r = b$ , it holds  $T_{S'}(j) \subseteq (a', S')_b = (a, S)_b \subseteq S(r)$ . Hence,  $S'(j) \subseteq S(r) \cup S'(j-1) \subseteq S'(\kappa(r)) \cup S'(j-1) \subseteq S'(j-1)$ . The latter holds because  $j > \kappa(r)$ . Thus,  $S'(j) = S'(j-1)$ , and consequently,  $T_{S'}(j) = \emptyset$ .  $\square$

Now we are able to prove the theorem which identifies short  $k$ -words of at most the double of the length of a given  $k$ -word, but with a hard inclusion property.

**Theorem 3.36.** Let  $a$  be any repetition-free  $k$ -word of length  $n$ ,  $k \geq 2$ . If there is a repetition-free  $k$ -word  $a'$  with  $a \not\subseteq a'$  and  $\mathcal{K}(a) \subseteq \mathcal{K}(a')$  then  $\mathcal{K}(a_1 a_2 \dots a_n) \subseteq \mathcal{K}(a_2 a_1 a_3 a_2 \dots a_n a_{n-1})$ .

*Proof.* Let  $a'$  be a  $k$ -word such that  $a \not\subseteq a'$  and  $\mathcal{K}(a) \subseteq \mathcal{K}(a')$ . First we will transform  $a'$  into a  $k$ -word of a certain structure preserving the inclusion. Note that inserting new letters in  $a'$  preserves  $\mathcal{K}(a) \subseteq \mathcal{K}(a')$ . Since  $a \not\subseteq a'$ , it holds that

$$a' = w_1 a_1 w_2 a_2 w_3 \dots w_i a_i w_{i+1} \quad \text{with } w_j \in (\{1, 2, \dots, k\} \setminus \{a_j\})^* \text{ and } i < n.$$

Define the  $k$ -word  $b'$  by appending  $a_{i+1} a_{i+2} \dots a_{n-1}$  to  $a'$  and then inserting  $a_2, a_3, \dots, a_n$  into the new  $k$ -word as follows:

$$b' =_{\text{def}} w_1 a_2 a_1 w_2 a_3 a_2 w_3 \dots w_{n-1} a_n a_{n-1} w_n.$$

Note that it holds that  $a \not\subseteq b'$ . By Lemma 3.35 we can simplify the words  $w_j$ . We can set

$$b'' =_{\text{def}} v_1 a_2 a_1 v_2 a_3 a_2 v_3 \dots v_{n-1} a_n a_{n-1} v_n \quad \text{with } v_i \in \{a_{i+1}, a_{i+2}, \dots, a_n\}^* \text{ and } v_n = \varepsilon,$$

i.e., for all  $i$ ,  $v_i$  is defined to be  $w_i$  without the letters from  $\{1, 2, \dots, k\} \setminus \{a_i, a_{i+1}, \dots, a_n\}$ . Using Lemma 3.34 and again Lemma 3.35, we can also simplify the words  $v_i$ . Let  $b'''$  be defined as

$$b''' =_{\text{def}} u_1 a_2 a_1 u_2 a_3 a_2 u_3 \dots u_{n-1} a_n a_{n-1} \\ \text{with } u_i \in (\{a_1, a_2, \dots, a_{i-1}\} \cap \{a_{i+1}, a_{i+2}, \dots, a_n\})^* \text{ and } u_1 = \varepsilon.$$

Making all subwords  $a_{i-1} u_i a_{i+1}$  repetition-free (note that this implies  $a_1 u_2 a_3 \equiv a_1 a_3$  and  $a_{n-2} u_{n-1} a_n \equiv a_{n-2} a_n$ ), we get the repetition-free  $k$ -word  $b$  defined as

$$b =_{\text{def}} a_2 a_1 a_3 a_2 z_3 a_4 a_3 z_4 \dots z_{n-2} a_{n-1} a_{n-2} a_n a_{n-1} \\ \text{with } z_i \in (\{a_1, a_2, \dots, a_{i-1}\} \cap \{a_{i+1}, a_{i+2}, \dots, a_n\})^* \text{ for } i \in \{3, 4, \dots, n-2\}.$$

This  $k$ -word  $b$  we will always suppose in the remainder. Note that  $b$  satisfies the conditions that  $a \not\subseteq b$  and  $\mathcal{K}(a) \subseteq \mathcal{K}(b)$ . Let  $\kappa$  be the canonical embedding of  $a$  into  $b$ . Let  $m = |b|$ . It holds that  $\kappa(1) = 2$  and  $\kappa(n-1) = m$ . We define  $\kappa'$  as  $\kappa'(j) = \kappa(j-1) - 1$  for all

$j \in \{2, \dots, n\}$ . Let  $S$  be any  $\mathcal{K}$ -homomorphism on  $a$ . Since  $\mathcal{K}(a) \subseteq \mathcal{K}(b)$ , and due to Lemma 3.33, there exists a  $\mathcal{K}$ -homomorphism  $V$  on  $b$  such that  $(a, S) = (b, V)$  and  $S(j) \subseteq V(\kappa(j))$  for all  $j \in \{1, 2, \dots, n-1\}$ . Define a mapping  $S'$  for  $j \in \{1, 2, \dots, m\}$  as

$$S'(j) =_{\text{def}} \begin{cases} V(j) & \text{if } j \in \{1, 2, m-1, m\}, \\ (V(j) \cap S(r)) \cup V(2) & \text{if } j > 2 \text{ and } \kappa'(r) \leq j < \kappa'(r+1). \end{cases}$$

It holds that  $S' : \{1, 2, \dots, m\} \rightarrow \mathcal{K}$  and  $S'(j) \subseteq S'(j+1)$  for  $1 \leq j < m$ , i.e.,  $S'$  is a  $\mathcal{K}$ -homomorphism on  $b$ . Moreover,  $S'$  satisfies the following conditions:

1. For all  $j \in \{1, \dots, m\}$ , if  $j \notin R_\kappa \cup R_{\kappa'}$ , then  $T_{S'}(j) = \emptyset$ ,
2.  $(a, S) = (b, S')$ .

Note that proving these two facts is sufficient for the theorem because of the equalities  $\kappa'(j) = \kappa(j-1) - 1$  for all  $j \in \{2, 3, \dots, n\}$ .

1. Let  $j \notin R_\kappa \cup R_{\kappa'}$ . Then,  $2 = \kappa(1) < j < \kappa'(n)$ , i.e., there is an  $r$  such that  $\kappa'(r) \leq j < \kappa'(r+1)$ . Consequently,

$$\begin{aligned} T_{S'}(j) &= S'(j) \setminus S'(j-1) = ((V(j) \cap S(r)) \cup V(2)) \setminus ((V(j-1) \cap S(r)) \cup V(2)) \\ &= ((V(j) \setminus V(j-1)) \cap S(r)) \setminus V(2) \subseteq T_V(j) \cap S(r). \end{aligned}$$

Let  $q$  be maximal with  $\kappa(q) < j$  and  $a_q = b_j$ . Let  $s$  be minimal with  $j < \kappa'(s)$  and  $a_s = b_j$ . The existence of both  $q$  and  $s$  is assured due to the structure of  $b$ . Then, we have  $T_{S'}(j) \subseteq T_V(j) \cap S(r) \subseteq T_V(j) \cap S(s-1)$ . Moreover,  $a_{s-1} \neq b_j$  because  $\kappa'(s-1) < j$  and  $j \notin R_{\kappa'}$ . The statement would be proven if we would know the following:

(\*) *There is no  $t$  with  $q < t < s$  and  $b_j = a_q = a_t = a_s$ .*

Using (\*) we can conclude: If  $x \in T_{S'}(j)$ , i.e.,  $x \in S(s-1)$  and  $x \notin V(j-1)$ , then  $x \notin T_S(i)$  for all  $q < i \leq s-1$ . Hence  $x \in S(q) \subseteq V(\kappa(q)) \subseteq V(j-1)$ . This is a contradiction. Thus,  $T_{S'}(j) = \emptyset$ .

It remains to prove (\*). Assume the contrary to be true, i.e., there exists a  $t$  with  $q < t < s$  and  $b_j = a_q = a_t = a_s$ . Then we have three cases yielding contradictions. The case  $j \geq \kappa(t)$  contradicts the maximality of  $q$  and  $q \neq t$ . The case  $j \leq \kappa'(t)$  contradicts the minimality of  $s$  and  $s \neq t$ . In the case  $\kappa'(t) < j < \kappa(t)$  we conclude  $\kappa(t-1) - 1 < j < \kappa(t)$  and, since  $a$  is repetition-free,  $\kappa(t-1) < j < \kappa(t)$ . But now, it holds that  $b_j \neq b_{\kappa(t)} = a_t$ , contradicting  $b_j = a_t$ . Hence the assumption is false, i.e., such a  $t$  does not exist.

2. It suffices to show  $T_{S'}(j) \subseteq (a, S)_i$  for every  $j$  with  $a_j = i$ . So, let  $j$  be so that  $a_j = i$ . There are two cases,  $j \in R_{\kappa'}$  and  $j \notin R_{\kappa'}$ .

- *Case  $j \in R_{\kappa'}$ .* If  $j = \kappa'(2) = \kappa(1) - 1 = 1$ , then  $T_{S'}(j) = T_V(j) \subseteq (b, V)_i = (a, S)_i$ . So, let  $j = \kappa'(r)$  for  $r > 2$ , i.e.,  $j > 2$  and  $i = b_j = a_r$ . Then,

$$\begin{aligned} T_{S'}(j) &= S'(j) \setminus S'(j-1) \\ &= ((V(j) \cap S(r)) \cup V(2)) \setminus ((V(j-1) \cap S(r-1)) \cup V(2)) \\ &= ((V(j) \cap S(r)) \setminus (V(j-1) \cap S(r-1))) \setminus V(2) \\ &\subseteq ((V(j) \setminus V(j-1)) \cap S(r)) \cup ((S(r) \setminus S(r-1)) \cap V(j-1)) \\ &\subseteq T_V(j) \cup T_S(r) \subseteq (b, V)_i \cup (a, S)_i = (a, S)_i. \end{aligned}$$



- *Case  $j \notin R_{\kappa'}$ .* If additionally  $j \notin R_{\kappa}$ , then by 1.,  $T_{S'}(j) = \emptyset \subseteq (a, S)_i$ . So, let  $j \in R_{\kappa}$ . If  $j = 2 = \kappa(1)$  or  $j = m = \kappa(n-1)$ , then  $T_{S'}(j) = T_V(j) \subseteq (b, V)_i = (a, S)_i$ . It remains to argue for  $2 = \kappa(1) < j < \kappa(n-1)$ . Then we have,

$$\begin{aligned} T_{S'}(j) &= S'(j) \setminus S'(j-1) \\ &= ((V(j) \cap S(r)) \cup V(2)) \setminus ((V(j-1) \cap S(r)) \cup V(2)) \\ &= ((V(j) \setminus V(j-1)) \cap S(r)) \setminus V(2) \subseteq T_V(j) \subseteq (b, V)_i = (a, S)_i. \end{aligned}$$

□

Note that  $a_1 a_2 \dots a_n \not\leq a_2 a_1 a_3 a_2 \dots a_n a_{n-1}$  for every repetition-free  $k$ -word  $a = a_1 \dots a_n$ . Theorem 3.36 gives, e.g., that for the 3-word 123 it is enough to collapse the polynomial hierarchy from  $\text{NP}(123) \subseteq \text{NP}(2132)$ . Moreover, Theorem 3.36 is in some sense optimal. For repetition-free 2-words  $a$ , it holds  $a_i = a_{i+2}$ . Hence, for  $a = a_1 \dots a_n$ , we have  $a_2 a_1 a_3 a_2 \dots a_n a_{n-1} \equiv \bar{a}$ .

**The Embedding Theorem for  $k$ -Chains.** We now prove the Embedding Conjecture true for  $k$ -words. First, we determine complete NP-partitions for partition classes over  $k$ -words with a useful inductive structure.

**Definition 3.37.** Let  $L \subseteq \Sigma^*$ . For any  $k$ -word  $a$  with  $|a| = n \geq 2$  and  $a_{n-1} \neq a_n$ , the partition  $L^a$  is defined as follows

1. If  $n = 2$ , then for all  $i \in \{1, 2, \dots, k\}$ ,

$$L_i^a =_{\text{def}} \begin{cases} L & \text{if } i = a_1, \\ \bar{L} & \text{if } i = a_2, \\ \emptyset & \text{if } i \notin \{a_1, a_2\}. \end{cases}$$

2. If  $n > 2$ , then for all  $i \in \{1, 2, \dots, k\}$ ,

$$L_i^a =_{\text{def}} \begin{cases} \left\{ \langle x_1, x_2, \dots, x_{n-1} \rangle \mid x_1 \in L \vee \langle x_2, x_3, \dots, x_{n-1} \rangle \in L_i^{a_2 a_3 \dots a_n} \right\} & \text{if } i = a_1, \\ \left\{ \langle x_1, x_2, \dots, x_{n-1} \rangle \mid x_1 \notin L \wedge \langle x_2, x_3, \dots, x_{n-1} \rangle \in L_i^{a_2 a_3 \dots a_n} \right\} & \text{if } i \neq a_1. \end{cases}$$

Easy inductive arguments show that  $L^a$  is really a partition. We need the definition of  $\leq_m^p$ -reduction for partitions: For  $k$ -partitions  $A$  and  $B$  it holds  $A \leq_m^p B$  iff there is a function  $f \in \text{FP}$  such that  $c_A(x) = c_B(f(x))$  for all  $x \in \Sigma^*$ .

**Theorem 3.38.** *Let  $L$  be a  $\leq_m^p$ -complete problem for NP. For any  $k$ -word  $a$  with  $|a| = n \geq 2$  and  $a_{n-1} \neq a_n$ , the partition  $L^f$  is  $\leq_m^p$ -complete for the partition class  $\text{NP}(a)$ .*

*Proof.* It is obvious that  $L^a$  is in  $\text{NP}(a)$ . The proof of hardness is by induction over the lengths  $n$  of  $k$ -words. The base of induction  $n = 2$  is obvious. So suppose the proposition is true for all  $k$ -words of length  $n$  and consider an arbitrary partition  $A \in \text{NP}(a)$  for a  $k$ -word  $a$  of length  $n+1$ , i.e., there is an NP-homomorphism  $S$  on  $a$  such that

$$A_{a_1} = S(1) \cup \bigcup_{\substack{a_j = a_1 \\ j > 2}} S(j) \setminus S(j-1) \quad \text{and for } i \neq a_1, \quad A_i = \bigcup_{a_j = i} S(j) \setminus S(j-1).$$

Clearly,  $S$  is also an NP-homomorphism on  $a_2 a_3 \dots a_{n+1}$ , and the defined partition  $A'$  belongs to  $\text{NP}(a_2 a_3 \dots a_{n+1})$ . Thus, since  $a_2 a_3 \dots a_{n+1}$  is a  $k$ -word of length  $n$ , by the assumption of the induction,  $A' \leq_m^p L^{a_2 a_3 \dots a_{n+1}}$  via  $\varphi \in \text{FP}$ . Further,  $S(1) \leq_m^p L$  via  $t \in \text{FP}$ . Define  $\psi$  as

$$\psi(x) =_{\text{def}} \langle t(x), (\pi_1^{n-1} \circ \varphi)(x), (\pi_2^{n-1} \circ \varphi)(x), \dots, (\pi_{n-1}^{n-1} \circ \varphi)(x) \rangle.$$

Clearly,  $\psi \in \text{FP}$ , and taking into account that  $S(1) \subseteq S(2) \subseteq \dots \subseteq S(n+1)$ , it holds that

$$\begin{aligned} x \in A_{a_1} &\iff x \in S(1) \text{ or } x \in \bigcup_{\substack{a_j = a_1 \\ j > 2}} S(j) \setminus S(j-1) \\ &\iff t(x) \in L \vee \varphi(x) \in L_{a_1}^{a_2 a_3 \dots a_{n+1}} \\ &\iff \psi(x) \in L_{a_1}^a \end{aligned}$$

and for  $i \neq a_1$ ,

$$\begin{aligned} x \in A_i &\iff x \notin S(1) \text{ and } x \in \bigcup_{a_j = i} S(j) \setminus S(j-1) \\ &\iff t(x) \notin L \wedge \varphi(x) \in L_i^{a_2 a_3 \dots a_{n+1}} \\ &\iff \psi(x) \in L_i^a. \end{aligned}$$

Hence,  $\psi$  shows  $A \leq_m^p L^a$ . This completes the induction.  $\square$

We apply the easy-hard technique invented by Kadin [Kad88] to collapse the polynomial hierarchy from a collapse of the boolean hierarchy  $\text{BH}_2(\text{NP})$ . The proof consists of two parts that can be isolated.

In the first part of the proof, an inclusion  $\text{NP}(m) \subseteq \text{coNP}(m)$  for some  $m \in \mathbb{N}_+$  is translated downwards to the previous level  $m-1$  using a special polynomial advice called hard word. Inductively, this can even be translated to the lowest level  $\text{NP} \subseteq \text{coNP}/\text{poly}$  where the polynomial advice is just a tuple of hard words. The second part of the proof uses this inclusion  $\text{NP} \subseteq \text{coNP}/\text{poly}$  to collapse the polynomial hierarchy to its third level. This part has been improved many times in sophisticated ways to a deeper collapse (cf. [HHH98b, RW98]) by a direct use of hard words.

Both parts of the proof are differently reflected by definitions. For the first part, the concept of hard sequences plays the crucial role.

**Definition 3.39.** [Kad88] Let  $L \subseteq \Sigma^*$ . Let  $m \in \mathbb{N}$ ,  $n \in \mathbb{N}_+$ , and  $h : \Sigma^* \rightarrow \Sigma^*$ . A tuple  $\langle \omega_1, \dots, \omega_j \rangle$  is said to be a *hard sequence* for  $(L, m, n, h)$  if and only if either  $j = 0$  or

1.  $1 \leq j \leq n-1$ ,
2.  $|\omega_j| \leq m$ ,
3.  $\omega_j \notin L$ ,
4.  $(\pi_{j+1}^n \circ h)(\langle \omega_1, \dots, \omega_j, x_{j+1}, \dots, x_n \rangle) \notin L$  for all  $x_{j+1}, \dots, x_n \in \Sigma^{\leq m}$ ,
5.  $\langle \omega_1, \dots, \omega_{j-1} \rangle$  is a hard sequence for  $(L, m, n, h)$ .

We call  $j$  the *order* of a hard sequence  $\langle \omega_1, \dots, \omega_j \rangle$ . A hard sequence  $\langle \omega_1, \dots, \omega_j \rangle$  for  $(L, m, n, h)$  is said to be a *maximal hard sequence* for  $(L, m, n, h)$  if and only if for all  $\omega_{j+1} \in \Sigma^*$ , the tuple  $\langle \omega_1, \dots, \omega_j, \omega_{j+1} \rangle$  is not a hard sequence for  $(L, m, n, h)$ .

Note that hard sequences do always exist independently from the parameters chosen, namely, at least hard sequences of order 0. Consequently, maximal hard sequences do always exist as well.

A second concept central to collapsing the polynomial hierarchy in the context of the easy-hard technique is that of a twister. The definition of a twister builds up on the concept of maximal hard sequences.

**Definition 3.40.** Let  $L \subseteq \Sigma^*$  and let  $n \in \mathbb{N}_+$ . A function  $h : \Sigma^* \rightarrow \Sigma^*$  is said to be an  $(L, n)$ -twister if and only if  $h \in \text{FP}$  and for all  $m \in \mathbb{N}$  and for all  $x \in \Sigma^{\leq m}$ , if  $\langle \omega_1, \dots, \omega_j \rangle$  is a maximal hard sequence for  $(L, m, n, h)$ , then there are  $x_{j+2}, \dots, x_n \in \Sigma^{\leq m}$  such that

$$x \notin L \iff (\pi_{j+1}^n \circ h)(\langle \omega_1, \dots, \omega_j, x, x_{j+2}, \dots, x_n \rangle) \in L.$$

The following result is the deepest collapse of the polynomial hierarchy known to follow from the existence of some twisters.

**Lemma 3.41.** [HHH98b, RW98] *Let  $L$  be  $\leq_m^p$ -complete for NP. Let  $n \in \mathbb{N}_+$ . If there exists an  $(L, n)$ -twister then  $\text{PH} = \Sigma_2^p(n-1) \oplus \text{NP}(n)$ .*

The next theorem generalizes the easy-hard technique to the case of partitions. This theorem is the key to the Embedding Theorem for  $k$ -chains.

**Theorem 3.42.** *Let  $k \geq 2$ . Let  $a$  and  $a'$  be  $k$ -words with  $|a| = |a'| = n \geq 2$ ,  $a_{n-1} \neq a_n$ ,  $a'_{n-1} \neq a'_n$ , and  $a_i \neq a'_i$  for all  $i \leq n$ . If  $\text{NP}(a) \subseteq \text{NP}(a')$ , then  $\text{PH} = \Sigma_2^p(n-2) \oplus \text{NP}(n-1)$ .*

*Proof.* Let  $L$  be a  $\leq_m^p$ -complete set for NP. Thus, by assumption  $\text{NP}(a) \subseteq \text{NP}(a')$ , there is a polynomial-time computable function  $h$  which witnesses the reduction  $L^a \leq_m^p L^{a'}$ . We will show that  $h$  is an  $(L, n-1)$ -twister. For that, we first have to prove the following claim.

**Claim.** *If  $\langle \omega_1, \dots, \omega_j \rangle$  is a hard sequence for  $(L, m, n-1, h)$ , then for all  $x_{j+1}, \dots, x_{n-1} \in \Sigma^{\leq m}$  and for all  $a \in \{1, 2, \dots, k\}$ ,*

$$\begin{aligned} \langle x_{j+1}, \dots, x_{n-1} \rangle &\in L_a^{a_{j+1} \dots a_n} \\ \iff (\langle \pi_{j+1}^{n-1}, \dots, \pi_{n-1}^{n-1} \rangle \circ h)(\langle \omega_1, \dots, \omega_j, x_{j+1}, \dots, x_{n-1} \rangle) &\in L_a^{a'_{j+1} \dots a'_n}. \end{aligned}$$

This claim can be proven inductively on the order  $j$  of hard sequences. The base of induction  $j = 0$  is just our given situation  $\text{NP}(a) \subseteq \text{NP}(a')$ . So, let  $\langle \omega_1, \dots, \omega_j, \omega_{j+1} \rangle$  be a hard sequence for  $(L, m, n-1, h)$ . Thus,  $\omega_{j+1} \notin L$  and for all  $x_{j+2}, \dots, x_{n-1} \in \Sigma^{\leq m}$  it holds that  $(\pi_{j+1}^{n-1} \circ h)(\langle \omega_1, \dots, \omega_j, \omega_{j+1}, x_{j+2}, \dots, x_{n-1} \rangle) \notin L$ . Hence, for  $b = a_{j+1}$ ,

$$\begin{aligned} \langle x_{j+2}, \dots, x_{n-1} \rangle &\in L_b^{a_{j+2} \dots a_n} \\ \iff \omega_{j+1} \in L \text{ or } \langle x_{j+2}, \dots, x_{n-1} \rangle &\in L_b^{a_{j+2} \dots a_n} \\ \iff \langle \omega_{j+1}, x_{j+2}, \dots, x_{n-1} \rangle &\in L_b^{a_{j+1} \dots a_n} \quad (\text{since } b = a_{j+1}) \\ \iff (\langle \pi_{j+1}^{n-1}, \dots, \pi_{n-1}^{n-1} \rangle \circ h)(\langle \omega_1, \dots, \omega_j, \omega_{j+1}, x_{j+2}, \dots, x_{n-1} \rangle) &\in L_b^{a'_{j+1} \dots a'_n} \\ &\quad (\text{by induction hypothesis}) \\ \iff (\pi_{j+1}^{n-1} \circ h)(\langle \omega_1, \dots, \omega_j, \omega_{j+1}, x_{j+2}, \dots, x_{n-1} \rangle) &\notin L \text{ and} \\ &\quad (\langle \pi_{j+2}^{n-1}, \dots, \pi_{n-1}^{n-1} \rangle \circ h)(\langle \omega_1, \dots, \omega_j, \omega_{j+1}, x_{j+2}, \dots, x_{n-1} \rangle) \in L_b^{a'_{j+2} \dots a'_n} \\ &\quad (\text{since } b \neq a'_{j+1}) \\ \iff (\langle \pi_{j+2}^{n-1}, \dots, \pi_{n-1}^{n-1} \rangle \circ h)(\langle \omega_1, \dots, \omega_j, \omega_{j+1}, x_{j+2}, \dots, x_{n-1} \rangle) &\in L_b^{a'_{j+2} \dots a'_n}. \end{aligned}$$

Now, consider  $b = a'_{j+1}$ . Then we conclude

$$\begin{aligned}
& \langle x_{j+2}, \dots, x_{n-1} \rangle \in L_b^{a_{j+2} \dots a_n} \\
& \iff \omega_{j+1} \notin L \text{ and } \langle x_{j+2}, \dots, x_{n-1} \rangle \in L_b^{a_{j+2} \dots a_n} \\
& \iff \langle \omega_{j+1}, x_{j+2}, \dots, x_{n-1} \rangle \in L_b^{a_{j+1} \dots a_n} \quad (\text{since } b \neq a_{j+1}) \\
& \iff (\langle \pi_{j+1}^{n-1}, \dots, \pi_{n-1}^{n-1} \rangle \circ h)(\langle \omega_1, \dots, \omega_j, \omega_{j+1}, x_{j+2}, \dots, x_{n-1} \rangle) \in L_b^{a'_{j+1} \dots a'_n} \\
& \quad \quad \quad (\text{by induction hypothesis}) \\
& \iff (\pi_{j+1}^{n-1} \circ h)(\langle \omega_1, \dots, \omega_j, \omega_{j+1}, x_{j+2}, \dots, x_{n-1} \rangle) \in L \text{ or} \\
& \quad \quad \quad (\langle \pi_{j+2}^{n-1}, \dots, \pi_{n-1}^{n-1} \rangle \circ h)(\langle \omega_1, \dots, \omega_j, \omega_{j+1}, x_{j+2}, \dots, x_{n-1} \rangle) \in L_b^{a'_{j+2} \dots a'_n} \\
& \quad \quad \quad (\text{since } b = a'_{j+1}) \\
& \iff (\langle \pi_{j+2}^{n-1}, \dots, \pi_{n-1}^{n-1} \rangle \circ h)(\langle \omega_1, \dots, \omega_j, \omega_{j+1}, x_{j+2}, \dots, x_{n-1} \rangle) \in L_b^{a'_{j+2} \dots a'_n}.
\end{aligned}$$

For the remaining case, let  $b \notin \{a_{j+1}, a'_{j+1}\}$ . Then

$$\begin{aligned}
& \langle x_{j+2}, \dots, x_{n-1} \rangle \in L_b^{a_{j+2} \dots a_n} \\
& \iff \omega_{j+1} \notin L \text{ and } \langle x_{j+2}, \dots, x_{n-1} \rangle \in L_b^{a_{j+2} \dots a_n} \\
& \iff \langle \omega_{j+1}, x_{j+2}, \dots, x_{n-1} \rangle \in L_b^{a_{j+1} \dots a_n} \quad (\text{since } b \neq a_{j+1}) \\
& \iff (\langle \pi_{j+1}^{n-1}, \dots, \pi_{n-1}^{n-1} \rangle \circ h)(\langle \omega_1, \dots, \omega_j, \omega_{j+1}, x_{j+2}, \dots, x_{n-1} \rangle) \in L_b^{a'_{j+1} \dots a'_n} \\
& \quad \quad \quad (\text{by induction hypothesis}) \\
& \iff (\pi_{j+1}^{n-1} \circ h)(\langle \omega_1, \dots, \omega_j, \omega_{j+1}, x_{j+2}, \dots, x_{n-1} \rangle) \notin L \text{ and} \\
& \quad \quad \quad (\langle \pi_{j+2}^{n-1}, \dots, \pi_{n-1}^{n-1} \rangle \circ h)(\langle \omega_1, \dots, \omega_j, \omega_{j+1}, x_{j+2}, \dots, x_{n-1} \rangle) \in L_b^{a'_{j+2} \dots a'_n} \\
& \quad \quad \quad (\text{since } b \neq a'_{j+1}) \\
& \iff (\langle \pi_{j+2}^{n-1}, \dots, \pi_{n-1}^{n-1} \rangle \circ h)(\langle \omega_1, \dots, \omega_j, \omega_{j+1}, x_{j+2}, \dots, x_{n-1} \rangle) \in L_b^{a'_{j+2} \dots a'_n}.
\end{aligned}$$

This completes the induction, and thus, the claim is proved.

Now, we prove that  $h$  is an  $(L, n-1)$ -twister, i.e., we have to show: If  $\langle \omega_1, \dots, \omega_j \rangle$  is a maximal hard sequence for  $(L, m, n-1, h)$ , then for all  $x_{j+1} \in \Sigma^{\leq m}$  there are  $x_{j+2}, \dots, x_{n-1} \in \Sigma^{\leq m}$  such that

$$x_{j+1} \notin L \iff (\pi_{j+1}^{n-1} \circ h)(\langle \omega_1, \dots, \omega_j, x_{j+1}, \dots, x_{n-1} \rangle) \in L.$$

There are different cases depending on the order  $j$  of the maximal hard sequence. If  $j = n-2 > 0$ , then the assertion reduces exactly to the claim above, having in mind that  $a_{n-1} \neq a'_{n-1}$ . If  $j < n-2$ , then for every  $x_{j+1} \in \Sigma^{\leq m}$ , the sequence  $\langle \omega_1, \dots, \omega_j, x_{j+1} \rangle$  is not a hard sequence, since  $\langle \omega_1, \dots, \omega_j \rangle$  is maximal. Consequently,  $x_{j+1} \in L$  or there are  $x_{j+2}, \dots, x_{n-1} \in \Sigma^{\leq m}$  with  $(\pi_{j+1}^{n-1} \circ h)(\langle \omega_1, \dots, \omega_j, x_{j+1}, x_{j+2}, \dots, x_{n-1} \rangle) \in L$ . Hence,  $x_{j+1} \notin L$  implies the latter case. This proves the direction from left to right. Conversely, the claim shows for all  $x_{j+2}, \dots, x_{n-1} \in \Sigma^{\leq m}$  and  $b = a'_{j+1} \neq a_{j+1}$

$$\begin{aligned}
& x_{j+1} \notin L \text{ and } \langle x_{j+2}, \dots, x_{n-1} \rangle \in L_b^{a_{j+2} \dots a_n} \\
& \iff (\pi_{j+1}^{n-1} \circ h)(\langle \omega_1, \dots, \omega_j, x_{j+1}, x_{j+2}, \dots, x_{n-1} \rangle) \in L \text{ or} \\
& \quad \quad \quad (\langle \pi_{j+2}^{n-1}, \dots, \pi_{n-1}^{n-1} \rangle \circ h)(\langle \omega_1, \dots, \omega_j, x_{j+1}, x_{j+2}, \dots, x_{n-1} \rangle) \in L_b^{a'_{j+2} \dots a'_n}.
\end{aligned}$$

Now, if there are  $x_{j+2}, \dots, x_{n-1} \in \Sigma^{\leq m}$  with  $(\pi_{j+1}^{n-1} \circ h)(\langle \omega_1, \dots, \omega_j, x_{j+1}, x_{j+2}, \dots, x_{n-1} \rangle) \in L$ , then  $x_{j+1} \notin L$ . Thus,  $h$  is an  $(L, n-1)$ -twister, and using Lemma 3.41 we obtain the statement desired.  $\square$

Theorem 3.43 merges hardest inclusions and the preceding theorem, yielding an upper bound for the polynomial hierarchy collapse in case of unlikely inclusions of partition classes over  $k$ -words.

**Theorem 3.43.** *Let  $a$  be any repetition-free  $k$ -word with  $k \geq 2$ . Let  $\delta_a = \|\{i \mid a_i = a_{i+2}\}\|$ . If there exists a  $k$ -word  $a'$  with  $a \not\leq a'$  and  $\text{NP}(a) \subseteq \text{NP}(a')$ , then  $\text{PH} = \Sigma_2^p(2|a| - \delta_a - 4) \oplus \text{NP}(2|a| - \delta_a - 3)$ .*

*Proof.* For any  $k$ -word  $z = z_1 \dots z_n$ , define the  $k$ -word  $\hat{z}$  to be the repetition-free version of the word  $z_2 z_1 z_3 z_2 \dots z_n z_{n-1}$ . Clearly, it holds  $|\hat{z}| = 2|z| - \delta_z - 2$ .

Let  $w$  be a shortest repetition-free  $k$ -subword of  $a$  with  $w \not\leq a'$ . Then, it holds  $|\hat{w}| \leq |\hat{a}|$ . This can be seen as follows: Assume that  $w$  emerges from  $a$  when only deleting the  $j$ -th letter in  $a$  and making the remainder repetition-free. Then,  $\delta_w \geq \delta_a - 2$  (by considering the worst case  $a_{j-2} = a_j$ ,  $a_{j-1} = a_{j+1}$ , and  $a_j = a_{j+2}$ ). Thus,

$$|\hat{w}| = 2(|a| - 1) - \delta_w - 2 \leq 2|a| - (\delta_a - 2) - 4 = 2|a| - \delta_a - 2 = |\hat{a}|.$$

By induction, we obtain  $|\hat{w}| \leq |\hat{a}|$  for arbitrary repetition-free  $k$ -subwords of  $a$ .

Because of  $w \not\leq a'$  and  $\text{NP}(w) \subseteq \text{NP}(a) \subseteq \text{NP}(a')$ , it holds  $\text{NP}(w) \subseteq \text{NP}(\hat{w})$  by Theorem 3.36. Let  $\kappa$  be the canonical embedding of  $w$  into  $\hat{w}$ . Let  $|w| = n$  and  $|\hat{w}| = m$ . Then, it holds  $|D_\kappa| = n - 1$ . Consider the  $k$ -word  $w'$  defined for all  $j \leq m$  by

$$w'_j =_{\text{def}} \begin{cases} w_r & \text{if } \kappa(r-1) \leq j < \kappa(r), \\ w_n & \text{if } j \geq \kappa(n-1). \end{cases}$$

Since  $|w| \leq |\hat{w}|$ , the  $k$ -word  $w'$  is well-defined. Moreover, the following facts are clearly true.

1.  $|w'| = |\hat{w}| = m$ ,
2.  $w' \equiv w$ ,
3.  $w'_m \neq w'_{m-1}$  (for  $\hat{w}$  this is true due to repetition-freeness).

In order to meet the assumptions of Theorem 3.42, it remains to prove  $w'_j \neq \hat{w}_j$  for all  $j \leq m$ . Assume the contrary to be true, i.e., there is a  $j \leq m$  such that  $w'_j = \hat{w}_j$ . Let  $s$  be maximal with  $\kappa(s-1) \leq j$ . Then,  $w'_j = w_s$  and consequently,  $\kappa(s) = j$ . But this is a contradiction to the repetition-freeness of  $w$ , if  $j = \kappa(s-1)$ , or to the definition of the canonical embedding  $\kappa$ , if  $j > \kappa(s-1)$  and  $s \in D_\kappa$ , or to  $w \not\leq \hat{w}$ , if  $j > \kappa(s-1)$  and  $s = n$ . Hence,  $w'_j \neq \hat{w}_j$  for all  $j \leq m$ . Now we can apply Theorem 3.42. Consequently, from our assumption  $\text{NP}(w') = \text{NP}(w) \subseteq \text{NP}(\hat{w})$ , we obtain  $\text{PH} = \Sigma_2^p(|\hat{w}| - 2) \oplus \text{NP}(|\hat{w}| - 1) \subseteq \Sigma_2^p(|\hat{a}| - 2) \oplus \text{NP}(|\hat{a}| - 1)$ .  $\square$

Summarizing all we have done so far we state the Embedding Theorem for  $k$ -chains as the formal confirmation of the Embedding Conjecture for  $k$ -chains.

**Theorem 3.44. (Embedding Theorem for NP with respect to  $k$ -chains.)** *Assume that the polynomial hierarchy is infinite. Let  $(G, f)$  and  $(G', f')$  be  $k$ -chains with  $k \geq 2$ . Then,  $(G, f) \leq (G', f')$  if and only if  $\text{NP}(G, f) \subseteq \text{NP}(G', f')$ .*

*Proof.* Without loss of generality, let  $a$  and  $a'$  be repetition-free  $k$ -words representing  $(G, f)$  and  $(G', f')$ . The direction from left to right is just the Embedding Lemma. For the other direction, let  $a \not\leq a'$ . Suppose  $\text{NP}(a) \subseteq \text{NP}(a')$ . Then by Theorem 3.43, the polynomial hierarchy is finite contradicting our assumption. Hence,  $\text{NP}(a) \not\subseteq \text{NP}(a')$ .  $\square$

We get once more that the Embedding Conjecture is generally true for 2-lattices. This is a consequence of Theorem 3.44 and the following simple proposition.

**Proposition 3.45.** *Every 2-lattice is equivalent to its longest chain with alternating labels 1 and 2.*

**Corollary 3.46.** *Assume the polynomial hierarchy is infinite. For 2-lattices  $(G, f)$  and  $(G', f')$  it holds that  $\text{NP}(G, f) \subseteq \text{NP}(G', f')$  if and only if  $(G, f) \leq (G', f')$ .*

**An Extension to  $k$ -Lattices.** In the preceding we have proved the Embedding Theorem for  $k$ -chains. Now we apply this theorem in order to get validity of the Embedding Conjecture for a large subclass of general  $k$ -lattices.

**Theorem 3.47.** *Assume that the polynomial hierarchy is infinite. Let  $(G, f)$  and  $(G', f')$  be  $k$ -lattices. If  $\text{NP}(G, f) \subseteq \text{NP}(G', f')$ , then every minimal  $k$ -subchain of  $(G, f)$  occurs as a  $k$ -subchain of  $(G', f')$ .*

*Proof.* Let  $\text{NP}(G, f) \subseteq \text{NP}(G', f')$ . Assume there is  $k$ -subchain  $(C, c)$ , identified with the  $k$ -word  $c$ , such that  $(C, c) \not\leq (G', f')$ . Let  $d^1, \dots, d^m$  be all  $k$ -words representing longest repetition-free  $k$ -subchains of  $(G', f')$ , and let  $\kappa_j$  be the canonical embedding of  $c$  into  $d^j$ . Let  $r$  denote the maximum of  $D_{\kappa_1} \cup \dots \cup D_{\kappa_m}$ . Define  $z$  to be the following  $k$ -word

$$\begin{aligned} z =_{\text{def}} & d_{\kappa_1(0)+1}^1 \cdots d_{\kappa_1(1)-1}^1 d_{\kappa_2(0)+1}^2 \cdots d_{\kappa_2(1)-1}^2 \cdots d_{\kappa_m(0)+1}^m \cdots d_{\kappa_m(1)-1}^m c_1 \cdot \\ & \cdot d_{\kappa_1(1)+1}^1 \cdots d_{\kappa_1(2)-1}^1 d_{\kappa_2(1)+1}^2 \cdots d_{\kappa_2(2)-1}^2 \cdots d_{\kappa_m(1)+1}^m \cdots d_{\kappa_m(2)-1}^m c_2 \cdot \\ & \cdot \dots \cdot \\ & \cdot d_{\kappa_1(r-1)+1}^1 \cdots d_{\kappa_1(r)-1}^1 d_{\kappa_2(r-1)+1}^2 \cdots d_{\kappa_2(r)-1}^2 \cdots d_{\kappa_m(r-1)+1}^m \cdots d_{\kappa_m(r)-1}^m c_r. \end{aligned}$$

Clearly,  $c \not\leq z$  and  $d^j \preceq z$  for all  $j \in \{1, 2, \dots, m\}$ . We prove  $\text{NP}(G', f') \subseteq \text{NP}(z)$ . For that, it suffices to show  $(G', f') \leq (\{1, 2, \dots, |z|\}, z)$ . We define a mapping  $\varphi : G' \rightarrow \{1, 2, \dots, |z|\}$  for  $x \in G'$  as follows

$$\varphi(x) =_{\text{def}} \bigvee_{\substack{e \text{ represents a chain through } x \\ e \preceq d^j}} \bigwedge_j (\kappa[d^j, z] \circ \kappa[e, d^j])(x).$$

We have to prove that  $\varphi$  is monotonic and  $f'(x) = z_{\varphi(x)}$ . The latter is obviously true by construction of  $\varphi$ . For the monotonicity, let  $x, y \in G'$  with  $x \leq y$ . Consider  $e$  representing a chain through  $x$ . Since the value  $\varphi(x)$  only depends on chain up to  $x$ , without loss of generality we can suppose  $e$  to represent a chain additionally going through  $y$  and we can suppose  $j$  to be so that  $(\kappa[d^j, z] \circ \kappa[e, d^j])(y)$  is minimal for all  $(\kappa[d^i, z] \circ \kappa[e, d^i])(y)$  with  $e \preceq d^i$ . Hence,  $\varphi(x) \leq (\kappa[d^j, z] \circ \kappa[e, d^j])(y) \leq \varphi(y)$ , and thus,  $\varphi$  is monotonic. Now we have a situation  $\text{NP}(c) \subseteq \text{NP}(G, f) \subseteq \text{NP}(G', f') \subseteq \text{NP}(z)$  but  $c \not\leq z$ . Consequently, by Theorem 3.44, this is contradiction to the strictness of the polynomial hierarchy. Hence, our assumption was false, and every repetition-free  $k$ -subchain of  $(G, f)$  is also a  $k$ -subchain of  $(G', f')$ .  $\square$

As an example, Theorem 3.47 easily gives that the 3-lattices in Figure 3.2 and Figure 3.3 define incomparable partition classes over NP, unless the polynomial hierarchy is finite.

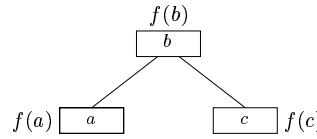

Fig. 3.8. The upper triangle

### 3.5.3 Evidence II: Beyond Chains

Assume that the polynomial hierarchy does not collapse. By Theorem 3.47, if the  $k$ -lattice  $(G, f)$  has a minimal  $k$ -subchain which is not a  $k$ -subchain of the  $k$ -lattice  $(G', f')$  then  $\text{NP}(G, f) \not\subseteq \text{NP}(G', f')$ . But what about  $k$ -lattices which have the same minimal  $k$ -subchains? For example, take the 3-lattices  $(G, f)$  and  $(G', f')$  represented in Figure 3.6, that have been used to vitiate the Embedding Theorem for recursively enumerable sets. Since  $(G, f) \not\subseteq (G', f')$  the Embedding Conjecture says that  $\text{NP}(G, f) \not\subseteq \text{NP}(G', f')$ . However, Theorem 3.47 does not help to show this because each subchain of  $(G, f)$  occurs in  $(G', f')$ .

In the following we will see that we can prove theorems similar to Theorem 3.47 for some simple substructures other than subchains. In particular, we get from Theorem 3.51 that for the 3-lattices  $(G, f)$  and  $(G', f')$  in Figure 3.6,  $\text{NP}(G, f) \not\subseteq \text{NP}(G', f')$  unless the polynomial hierarchy is finite.

**The Upper Triangle.** The first structure we investigate is the upper triangle as presented in Figure 3.8. The main result with respect to upper triangles is Theorem 3.49. The key to prove this theorem is the following lemma. The proof of this lemma is inspired by a work of Hemaspaandra *et al.* [HHN<sup>+</sup>95].

**Lemma 3.48.** *If for all sets  $A, B \in \text{NP}$  there exist sets  $C, D \in \text{NP}$  such that  $C \cup D = \Sigma^*$ ,  $C \subseteq \overline{B \setminus A}$ , and  $D \subseteq \overline{A \setminus B}$ , then  $\text{NP} = \text{coNP}$ .*

*Proof.* Suppose that the premise of the lemma is true. Consider the sets  $A$  and  $B$  defined as

$$\begin{aligned} A &=_{\text{def}} \{ \langle F_1, F_2 \rangle \mid F_1 \in \text{SATISFIABILITY} \} \\ B &=_{\text{def}} \{ \langle F_1, F_2 \rangle \mid F_2 \in \text{SATISFIABILITY} \} \end{aligned}$$

Obviously,  $A$  and  $B$  belong to  $\text{NP}$ . The supposition implies that there are  $\text{NP}$  sets  $C$  and  $D$  with  $C \cup D = \Sigma^*$ ,  $C \subseteq \overline{B \setminus A}$ , and  $D \subseteq \overline{A \setminus B}$ . Let  $M_1$  and  $M_2$  be nondeterministic polynomial-time Turing machines accepting  $C$  and  $D$ , i.e.,  $L(M_1) = C$  and  $L(M_2) = D$ .

Recall that for a propositional formula  $H$ ,  $H \in \text{SATISFIABILITY}$  if and only if  $H_0 \in \text{SATISFIABILITY}$  or  $H_1 \in \text{SATISFIABILITY}$ .

Let  $M_1 \times M_2$  be that machine that on an input  $\langle F_1, F_2 \rangle$  first simulates  $M_1$  on  $F_1$  (ending with result  $\alpha$ ) and then simulates  $M_2$  on  $F_2$  (ending with result  $\beta$ ). Consider  $M_1 \times M_2$  on an input  $\langle H_0, H_1 \rangle$  for a propositional formula  $H$  along an arbitrary computation path.

- *Case  $(\alpha, \beta) = (1, 1)$ .* That is  $\langle H_0, H_1 \rangle \in C \cap D \subseteq \overline{B \setminus A} \cap \overline{A \setminus B} = (A \cap B) \cup \overline{A \cup B}$ .
  - If  $\langle H_0, H_1 \rangle \in A \cap B$ , then  $H, H_0, H_1 \in \text{SATISFIABILITY}$ .
  - If  $\langle H_0, H_1 \rangle \in \overline{A \cup B}$ , then  $H, H_0, H_1 \notin \text{SATISFIABILITY}$ .

All in all,

$$H \in \text{SATISFIABILITY} \iff H_0 \in \text{SATISFIABILITY}.$$

- *Case*  $(\alpha, \beta) = (1, 0)$ . That is, we know  $\langle H_0, H_1 \rangle \in C$  and we assume moreover,  $\langle H_0, H_1 \rangle \in C \setminus D = E \cup F \cup G$ , where  $E \subseteq \overline{A \cup B}$ ,  $F = A \setminus B$ , and  $G \subseteq A \cap B$ .
  - If  $\langle H_0, H_1 \rangle \in E \subseteq \overline{A \cup B}$ , then  $H, H_0, H_1 \notin \text{SATISFIABILITY}$ .
  - If  $\langle H_0, H_1 \rangle \in G \subseteq A \cap B$ , then  $H, H_0, H_1 \in \text{SATISFIABILITY}$ .
  - If  $\langle H_0, H_1 \rangle \in F = A \setminus B$ , then  $H, H_0 \in \text{SATISFIABILITY}$ .

All in all,

$$H \in \text{SATISFIABILITY} \iff H_0 \in \text{SATISFIABILITY}.$$

- *Case*  $(\alpha, \beta) = (0, 1)$ . Analogous arguments as for  $(\alpha, \beta) = (1, 0)$  show

$$H \in \text{SATISFIABILITY} \iff H_1 \in \text{SATISFIABILITY}.$$

- *Case*  $(\alpha, \beta) = (0, 0)$ . Since  $C \cup D = \Sigma^*$  there is always an accepting path. Thus this case is irrelevant.

Define  $M$  to be a machine that on input  $H$  works in the following way:  $M$  simulates  $M_1 \times M_2$  on  $\langle H_0, H_1 \rangle$  to answer the question  $H \in \overline{\text{SATISFIABILITY}}$ .  $M$  rejects along computation paths with results  $(0, 0)$ . Along a computation path with results  $(1, 1)$  or  $(1, 0)$ ,  $M$  simulates  $M_1 \times M_2$  on input  $\langle H_{00}, H_{01} \rangle$  to answer the question  $H_0 \in \overline{\text{SATISFIABILITY}}$ . Along paths with  $(0, 1)$ ,  $M$  simulates  $M_1 \times M_2$  on  $\langle H_{10}, H_{11} \rangle$  to answer the question  $H_1 \in \overline{\text{SATISFIABILITY}}$ . Continuing in this way we obtain after  $n$  simulations of  $M_1 \times M_2$  where  $n$  is number of variables in  $H$  a question  $H_{\alpha_0 \alpha_1 \dots \alpha_n} \in \overline{\text{SATISFIABILITY}}$ . Answer this question with negation of  $H_{\alpha_0 \alpha_1 \dots \alpha_n}$ . Clearly,  $M$  runs in polynomial time and  $L(M) = \overline{\text{SATISFIABILITY}}$ . Hence,  $\text{SATISFIABILITY} \in \text{coNP}$ .  $\square$

**Theorem 3.49.** *Assume that  $\text{NP} \neq \text{coNP}$ . Let  $(G, f)$  and  $(G', f')$  be  $k$ -lattices with  $k \geq 3$ . If  $\text{NP}(G, f) \subseteq \text{NP}(G', f')$  then all  $k$ -subposets in  $(G, f)$  having the form as in Figure 3.8 with pairwise different labels  $f(a)$ ,  $f(b)$ , and  $f(c)$  do also occur in  $(G', f')$ .*

*Proof.* Let  $(G, f)$  and  $(G', f')$  be  $k$ -lattices. Suppose that  $\text{NP}(G, f) \subseteq \text{NP}(G', f')$ . Suppose that there exists a  $k$ -subposet of  $(G, f)$  as described in Figure 3.8. So let  $\{a, b, c\} \subseteq G$  be such that  $a < b$ ,  $c < b$ ,  $a$  and  $c$  are incomparable, and  $\|\{f(a), f(b), f(c)\}\| = 3$ . Because of Proposition 3.27, without loss of generality we can assume that  $f(a) = 1$ ,  $f(b) = 2$ , and  $f(c) = 3$ . The proof is by contradiction. That is, we assume to the contrary that there exist no  $a', b', c' \in G'$  with  $a' < b'$ ,  $c' < b'$ ,  $f'(a') = 1$ ,  $f'(b') = 2$ , and  $f'(c') = 3$ .

Let  $A$  and  $B$  be arbitrary sets in  $\text{NP}$ . Define a mapping  $S : G \rightarrow \text{NP}$  for all  $z \in G$  as

$$S(z) =_{\text{def}} \begin{cases} \Sigma^* & \text{if } z \geq b, \\ A \cup B & \text{if } z \geq a, z \geq c, \text{ and } z \not\geq b, \\ A & \text{if } z \geq a \text{ and } z \not\geq c, \\ B & \text{if } z \not\geq a \text{ and } z \geq c, \\ A \cap B & \text{if } z \not\geq a \text{ and } z \not\geq c. \end{cases}$$

It is easily seen that  $S$  is an  $\text{NP}$ -homomorphism on  $G$  and that  $T_S(0_G) = A \cap B$ ,  $T_S(a) = A \setminus B$ ,  $T_S(c) = B \setminus A$ , and  $T_S(b) = \overline{A \cup B}$ . Depending on the value  $f(0_G)$  we have several  $k$ -partitions defined by  $(G, f)$  and  $S$ . Without loss of generality, we can assume that  $f(0_G) \in \{1, 2, 3, 4\}$ . This gives the following four  $k$ -partitions:



$$(G, f, S) = \begin{cases} (A, \overline{A \cup B}, B \setminus A, \emptyset, \emptyset, \dots, \emptyset) & \text{if } f(0_G) = 1 \\ (A \setminus B, (A \cap B) \cup \overline{A \cup B}, B \setminus A, \emptyset, \emptyset, \dots, \emptyset) & \text{if } f(0_G) = 2 \\ (A \setminus B, \overline{A \cup B}, B, \emptyset, \emptyset, \dots, \emptyset) & \text{if } f(0_G) = 3 \\ (A \setminus B, \overline{A \cup B}, B \setminus A, A \cap B, \emptyset, \dots, \emptyset) & \text{if } f(0_G) = 4 \end{cases}$$

Since  $\text{NP}(G, f) \subseteq \text{NP}(G', f')$  there is an NP-homomorphism  $S'$  on  $G'$  with  $(G, f, S) = (G', f', S')$ . We consider the following sets of elements of  $G'$ :

$$\begin{aligned} U_1 &=_{\text{def}} \{ z \in G' \mid f'(z) = 2 \wedge (\forall x, x \leq z)[f'(x) \neq 3] \}, \\ U_3 &=_{\text{def}} \{ z \in G' \mid f'(z) = 2 \wedge (\forall x, x \leq z)[f'(x) \neq 1] \}. \end{aligned}$$

Since there exist no  $a', b', c' \in G'$  with  $a' < b', c' < b', f'(a') = 1, f'(b') = 2$ , and  $f'(c) = 3$ , it holds that  $U_1 \cup U_3 = \{ z \in G' \mid f'(z) = 2 \}$ . Define sets  $C$  and  $D$  as

$$C =_{\text{def}} A \cup \bigcup_{z \in U_1} S'(z) \quad \text{and} \quad D =_{\text{def}} B \cup \bigcup_{z \in U_3} S'(z).$$

Clearly,  $C, D \in \text{NP}$ . Moreover the following is true:

1.  $C \cup D = \Sigma^*$ ,
2.  $C \subseteq \overline{B \setminus A}$ ,
3.  $D \subseteq A \setminus B$ .

This can be verified as follows:

1. Let  $x \notin (\bigcup_{z \in U_1} S'(z)) \cup (\bigcup_{z \in U_3} S'(z))$ . Then  $x \notin (G', f', S')_2$ . We conclude

$$\begin{aligned} \overline{(G', f', S')_2} &= (G', f', S')_1 \cup (G', f', S')_3 \cup (G', f', S')_4 \\ &= (G, f, S)_1 \cup (G, f, S)_3 \cup (G, f, S)_4 \subseteq A \cup B. \end{aligned}$$

Thus,  $x \in A \cup B$ . Hence, for all  $x \in \Sigma^*$  we have that  $x \in C \cup D$ .

2. Obviously,  $A \subseteq \overline{B \setminus A}$ . Furthermore,

$$\begin{aligned} \bigcup_{z \in U_1} S'(z) &\subseteq (G', f', S')_1 \cup (G', f', S')_2 \cup (G', f', S')_4 \\ &= (G, f, S)_1 \cup (G, f, S)_2 \cup (G, f, S)_4 = \overline{(G, f, S)_3} \subseteq \overline{B \setminus A}. \end{aligned}$$

Consequently,  $C \subseteq \overline{B \setminus A}$ .

3. Analogous argumentation as for the second statement.

Since  $A$  and  $B$  were arbitrarily chosen, we can apply Lemma 3.48. This implies that  $\text{NP} = \text{coNP}$ . Hence, a contradiction.  $\square$

**The Lower Triangle.** The structure dual to the upper triangle is the lower triangle presented in Figure 3.9. Although the proof of Theorem 3.51 which is here the main result similar to Theorem 3.49 uses the duality of the structures, the key lemma for establishing the theorem works different to Lemma 3.48. Interestingly, we are not able to prove the strong consequence that NP is closed under complementation as in Lemma 3.8 but only by taking polynomial advice. The proof involves techniques of Ko [Ko83] and Hemaspaandra *et al.* [HNOS96].

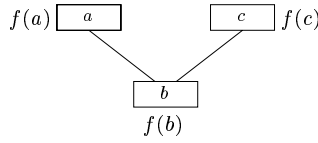

**Fig. 3.9.** The lower triangle

**Lemma 3.50.** *If for all sets  $A, B \in \text{NP}$  there exist sets  $C, D \in \text{NP}$  such that  $A \setminus B \subseteq C$ ,  $B \setminus A \subseteq D$ , and  $C \cap D = \emptyset$ , then  $\text{NP} \subseteq \text{coNP}/\text{poly}$ .*

*Proof.* Suppose that the premise of the lemma is true. Let  $L \in \text{NP}$ . Define the sets  $A$  and  $B$  as follows:

$$\begin{aligned} A &=_{\text{def}} \{ \langle x, y \rangle \mid \min\{x, y\} \in L \} \\ B &=_{\text{def}} \{ \langle x, y \rangle \mid \max\{x, y\} \in L \} \end{aligned}$$

The supposition implies that there are NP sets  $C$  and  $D$  with  $A \setminus B \subseteq C$ ,  $B \setminus A \subseteq D$ , and  $C \cap D = \emptyset$ . On an intuitive level, if  $x \leq y$ , then “ $\langle x, y \rangle \in C$ ” means “if  $y \in L$  then  $x \in L$ ”, and “ $\langle x, y \rangle \in D$ ” means “if  $x \in L$  then  $y \in L$ ”.

Let  $n_0 \in \mathbb{N}$  be the smallest number such that  $L \cap \Sigma^{\leq n_0}$  is non-empty. Let  $n \geq n_0$  be an arbitrary natural number. We construct a set  $S_n$  that will serve as an advice for strings of length  $\leq n$ . Define for  $z \in \Sigma^{\leq n}$  the set  $B(z)$  as

$$B(z) =_{\text{def}} \left\{ x \in \Sigma^{\leq n} \mid [x \neq z \wedge (x < z \rightarrow \langle x, z \rangle \in C) \wedge (z < x \rightarrow \langle x, z \rangle \in D)] \vee (x < z \wedge \langle x, z \rangle \notin C \cup D) \right\}.$$

If  $G \subseteq L \cap \Sigma^{\leq n}$ , then for all  $x, z \in G$  with  $x \neq z$  either  $x \in B(z)$  or  $z \in B(x)$ . This gives

$$\sum_{z \in G} \|B(z) \cap G\| = \binom{\|G\|}{2} \quad \text{for all } G \subseteq L \cap \Sigma^{\leq n}. \quad (3.2)$$

For a set  $G \subseteq \Sigma^{\leq n}$ , let  $y_G$  be a word in  $G$  such that  $\|B(y_G) \cap G\| \geq \|B(x) \cap G\|$  for all  $x \in G$ . We consider a certain sequence of sets  $\{G_1, G_2, \dots\}$ . In particular, we are interested in the words  $y_{G_j}$ . Let  $y_j$  denote  $y_{G_j}$ . Then for all  $j \in \mathbb{N}_+$ , the sets  $G_j$  are inductively defined as follows:

$$\begin{aligned} G_1 &=_{\text{def}} L \cap \Sigma^{\leq n} && \text{if } j = 1 \\ G_j &=_{\text{def}} G_{j-1} \setminus (\{y_{j-1}\} \cup B(y_{j-1})) && \text{if } j \geq 2. \end{aligned}$$

The following can be shown by inductive arguments:

$$\|G_j\| \leq \frac{\|G_1\|}{2^{j-1}} \quad \text{for all } j \in \mathbb{N}_+. \quad (3.3)$$

For  $j = 1$ , this obvious. For  $j \geq 2$ , using Equation (3.2) we easily observe that

$$\|B(y_{j-1}) \cap G_{j-1}\| \geq \frac{\|G_{j-1}\| - 1}{2}.$$

Thus we can conclude

$$\|G_j\| \leq \|G_{j-1}\| - \left(1 + \frac{\|G_{j-1}\| - 1}{2}\right) \leq \frac{\|G_{j-1}\|}{2} \leq \frac{\|G_1\|}{2^{j-1}}.$$

From Equation (3.3) it immediately follows that there is a smallest  $r$  such that for all  $s \geq r$ ,  $G_s = \emptyset$ . It holds that  $r \leq 2 + \log_2 \|G_1\| \leq 2 + \log_2 2^{n+1} \leq n + 3$ . Now let  $S_n$  be the set

$$S_n =_{\text{def}} \{y_1, y_2, \dots, y_{r-1}\}.$$

Thus,  $\|S_n\| \leq n + 2$ . Moreover, we obtain that  $S_n \subseteq L$  and that for all  $x \in \Sigma^{\leq n}$ , the following holds:

- If  $x \in L$  then there is an  $y \in S_n$  such that exactly *one* of the following statements is true:
  - $x = y$  or
  - if  $x < y$  then  $\langle x, y \rangle \in C$ , and if  $y < x$  then  $\langle x, y \rangle \in D$ , or
  - $x < y$  and  $\langle x, y \rangle \notin C \cup D$ .
- If  $x \notin L$  then it holds that for all  $y \in S_n$ , *all* of the following statements are true:
  - $x \neq y$  and
  - if  $x < y$  then  $\langle x, y \rangle \in D$  and
  - if  $y < x$  then  $\langle x, y \rangle \in C$ .

From this we can conclude that for all  $x \in \Sigma^{\leq n}$ ,

$$x \in L \iff \text{there exists an } y \in S_n \text{ such that } x = y \text{ or the following is true:} \\ \text{if } x < y \text{ then } \langle x, y \rangle \notin D, \text{ and if } y < x \text{ then } \langle x, y \rangle \notin C.$$

Define a set  $A'$  as follows:

$$A' =_{\text{def}} \left\{ \langle x, T \rangle \mid |x| \geq n_0 \wedge T \subseteq \Sigma^{\leq n} \wedge \|T\| \leq n + 1 \wedge \right. \\ \left. (\exists y \in T) [x = y \vee ((x < y \rightarrow \langle x, y \rangle \notin D) \wedge (y < x \rightarrow \langle x, y \rangle \notin C))] \right\}$$

It is easily seen that  $A'$  is in coNP. Define the advice function  $h$  as

$$h(n) =_{\text{def}} \begin{cases} S_n & \text{if } n \geq n_0, \\ \emptyset & \text{if } n < n_0. \end{cases}$$

Clearly,  $h$  has polynomial length in  $n$ , i.e.,  $h \in \text{poly}$ . Furthermore, we have that for all  $x \in \Sigma^*$ ,

$$x \in L \iff \langle x, h(|x|) \rangle \in A'.$$

Hence,  $L \in \text{coNP}(\text{poly})$ . □

**Theorem 3.51.** *Assume that the polynomial hierarchy is infinite. Let  $(G, f)$  and  $(G', f')$  be  $k$ -lattices with  $k \geq 3$ . If  $\text{NP}(G, f) \subseteq \text{NP}(G', f')$  then all  $k$ -subposets in  $(G, f)$  having the form as in Figure 3.9 with pairwise different labels  $f(a)$ ,  $f(b)$ , and  $f(c)$  do also occur in  $(G', f')$ .*

*Proof.* Let  $(G, f)$  and  $(G', f')$  be  $k$ -lattices. Suppose that  $\text{NP}(G, f) \subseteq \text{NP}(G', f')$ . Suppose that there exists a  $k$ -subposet of  $(G, f)$  as described in Figure 3.9. So let  $\{a, b, c\} \in G$  be such that  $a > b$ ,  $c > b$ ,  $a$  and  $c$  are incomparable, and  $\|\{f(a), f(b), f(c)\}\| = 3$ . We assume to the contrary that there exist no  $a', b', c' \in G'$  with  $a' > b'$ ,  $c' > b'$ ,  $f'(a') = f(a)$ ,  $f'(b') = f(b)$ , and  $f'(c') = f(c)$ .

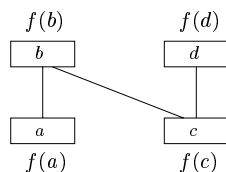

**Fig. 3.10.** A next step towards resolution of the Embedding Conjecture

Theorem 3.16 implies that  $\text{coNP}(G^\partial, f) \subseteq \text{coNP}(G'^\partial, f')$ . Thus, our situation translates exactly to the situation in Theorem 3.49 with respect to  $\text{coNP}$ . Following the proof of Theorem 3.49 we obtain that for all sets  $A, B \in \text{coNP}$ , there exist sets  $C, D \in \text{coNP}$  with  $C \cup D = \Sigma^*$ ,  $C \subseteq \overline{B \setminus A}$ , and  $D \subseteq \overline{A \setminus B}$ . This easily implies that for all sets  $A, B \in \text{NP}$ , there exist sets  $C, D \in \text{NP}$  such that  $C \cap D = \emptyset$ ,  $A \setminus B \subseteq C$ , and  $B \setminus A \subseteq D$ . By Lemma 3.50, it follows that  $\text{NP} \subseteq \text{coNP}/\text{poly}$ , hence the polynomial hierarchy is finite. Thus we have a contradiction.  $\square$

From Theorem 3.51 we easily obtain that, assuming an infinite polynomial hierarchy,  $\text{NP}(G, f) \not\subseteq \text{NP}(G', f')$  for  $(G, f)$  being the left 3-lattice and  $(G', f')$  being the right 3-lattice in Figure 3.6. So the counterexample to the Embedding Theorem for recursively enumerable sets is not a counterexample to the Embedding Conjecture.

### 3.5.4 Next Steps Towards Resolution

All the theorems we proved in the last subsections to support the Embedding Conjecture are of the following shape:

*Assume the polynomial hierarchy is infinite. Let  $(G, f)$  and  $(G', f')$  be  $k$ -lattices. If  $\text{NP}(G, f) \subseteq \text{NP}(G', f')$  then all  $k$ -subposets of  $(G, f)$  having a certain pattern  $\mathbf{P}$  do also occur in  $(G', f')$ .*

The patterns for which the according theorem holds are chains, lower, and upper triangles. Progress towards an affirmative resolution of the conjecture means to enlarge this class of patterns. Because the previous theorems all need different proof techniques we have not been able to learn very much from these solutions. It will be important to prove new patterns step by step. The pattern which is the next candidate to be resolved is pictured in Figure 3.10. The difficult case is  $f(b) = f(c)$  and  $f(b) \notin \{f(a), f(d)\}$ . Reference issues can be found in the following section.

## 3.6 On the Structure of $\text{BH}_3(\text{NP})$

Assume the Embedding Conjecture is true and an infinite polynomial hierarchy. Then the structure of the boolean hierarchy of  $k$ -partitions with respect to set inclusion is identical with the partial order of  $\leq$ -equivalence classes of  $k$ -lattices with respect to  $\leq$ . To get an idea of the complexity of the latter structure we will now present the partial order of all equivalence classes of 3-lattices which include a boolean 3-lattice of the form  $(\{1, 2\}^3, f)$  with surjective  $f$  (for non-surjective  $f$  these  $k$ -lattices do not really define 3-partitions). The 5796 different boolean 3-lattices of the form  $(\{1, 2\}^3, f)$  with surjective  $f$  are in 132 different equivalence classes.

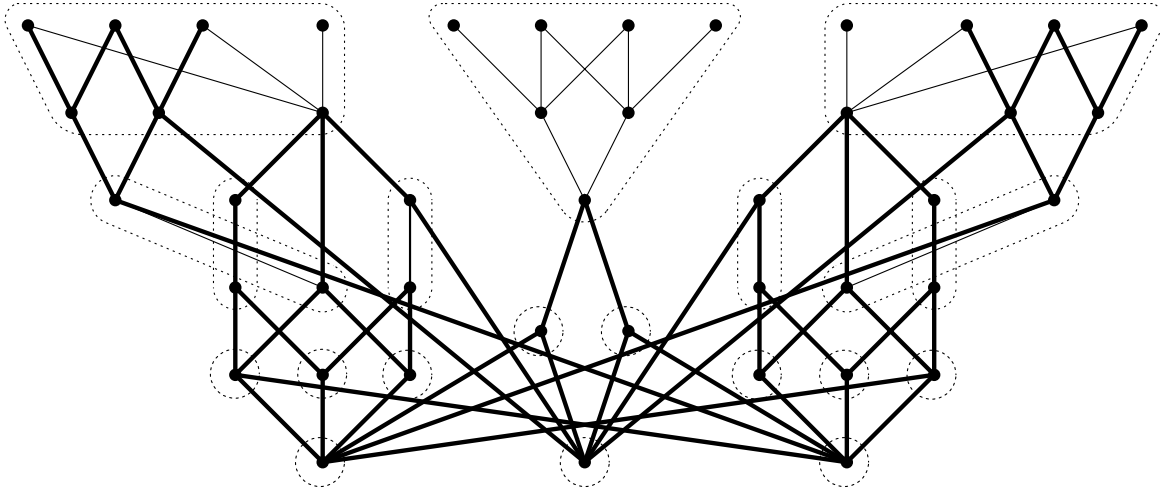

**Fig. 3.11.** Scheme of all boolean 3-lattices of the form  $(\{1, 2\}^3, f)$  with  $f(1, 1, 1) = 1$

Figure 3.11 shows the partial order of the 44 equivalence classes which contain boolean 3-lattices of the form  $(\{1, 2\}^3, f)$  such that  $f(1, 1, 1) = 1$ . The cases  $f(1, 1, 1) = 2$  and  $f(1, 1, 1) = 3$  yield isomorphic partial orders. A line from equivalence class  $\mathbf{G}$  up to equivalence class  $\mathbf{G}'$  means that  $(G, f) < (G', f')$  for every  $(G, f) \in \mathbf{G}$  and  $(G', f') \in \mathbf{G}'$ . We emphasize that such a study would be intractable without the possibility to present boolean  $k$ -lattices by equivalent  $k$ -lattices. All 3-lattices in equivalence classes framed by the same dotted line have the same minimal labeled subchains.

Figure 3.12 shows the middle part and Figure 3.13 shows the right part of the partial order in Figure 3.11. In both diagrams, each equivalence class is represented by the minimal 3-lattice. The left part of the partial order in Figure 3.11 is symmetric to the right part where the labels 2 and 3 change their role.

**Theorem 3.52.** *Assume the polynomial hierarchy is infinite. If in Figure 3.12 and Figure 3.13 there is a thick line from class  $\mathbf{G}$  up to class  $\mathbf{G}'$  then  $\text{NP}(G, f) \subset \text{NP}(G', f')$  for every  $(G, f) \in \mathbf{G}$  and  $(G', f') \in \mathbf{G}'$ .*

Every “thick line” in this theorem is an application of Theorem 3.47 besides the one’s marked by  $\wedge$  or  $\vee$  which are just Theorem 3.49 (for  $\wedge$ ) and Theorem 3.51 (for  $\vee$ ).

At the end of this section we mention that the boolean hierarchy of 3-partitions over NP does not have bounded width with respect to set inclusion unless the polynomial hierarchy collapses.

**Proposition 3.53.** *Assume that the polynomial hierarchy is infinite. For every  $m \in \mathbb{N}$  there exist at least  $m$  partition classes in  $\text{BH}_3(\text{NP})$  that are incomparable with respect to set inclusion.*

*Proof.* Let  $m \in \mathbb{N}$ . We define  $m$  3-chains that are incomparable with respect to  $\leq$ . Let  $G_m = (\{1, 2, \dots, m\}, \leq)$  be the chain with the natural order on  $\{1, 2, \dots, m\}$ . For every  $i \in \{1, 2, \dots, m\}$  let  $f_m^i : G_m \rightarrow \{1, 2, 3\}$  be the function defined as

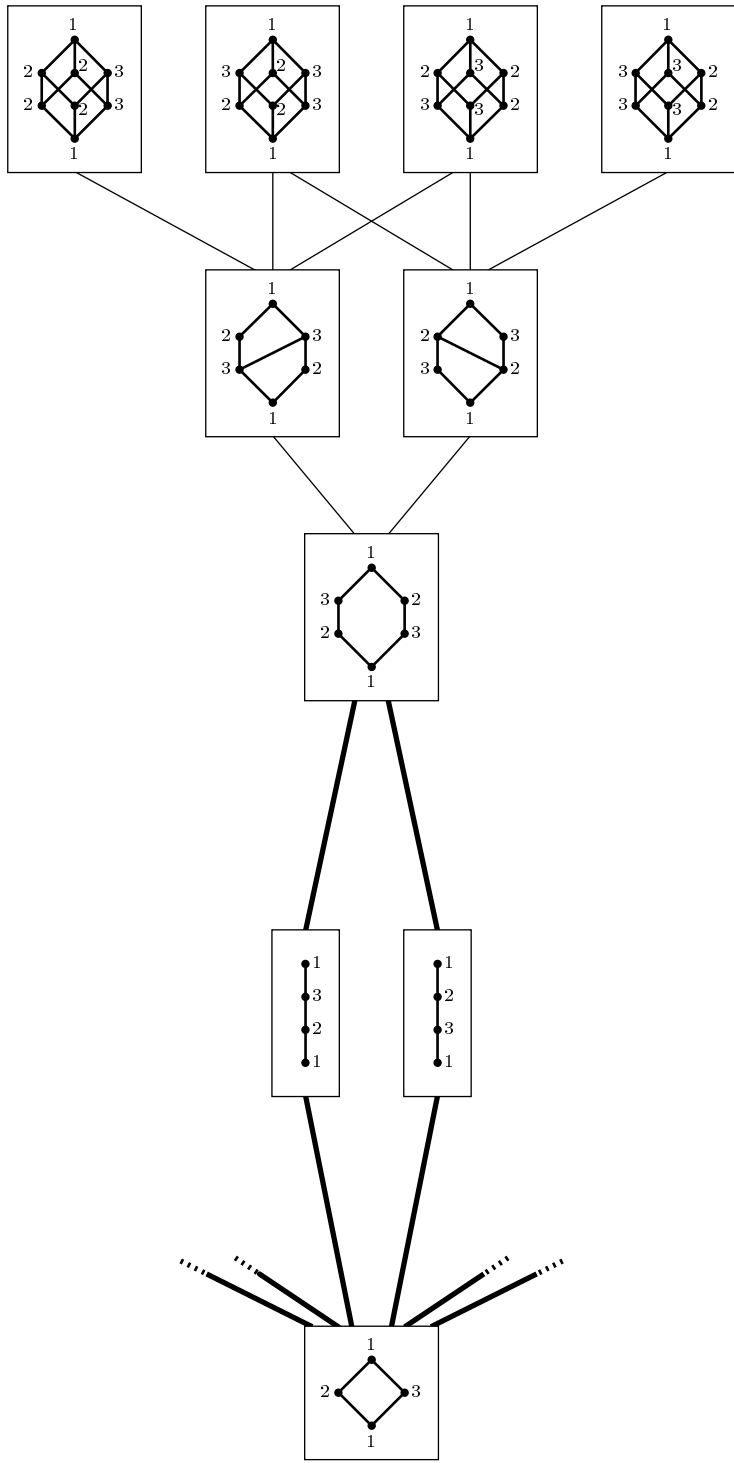
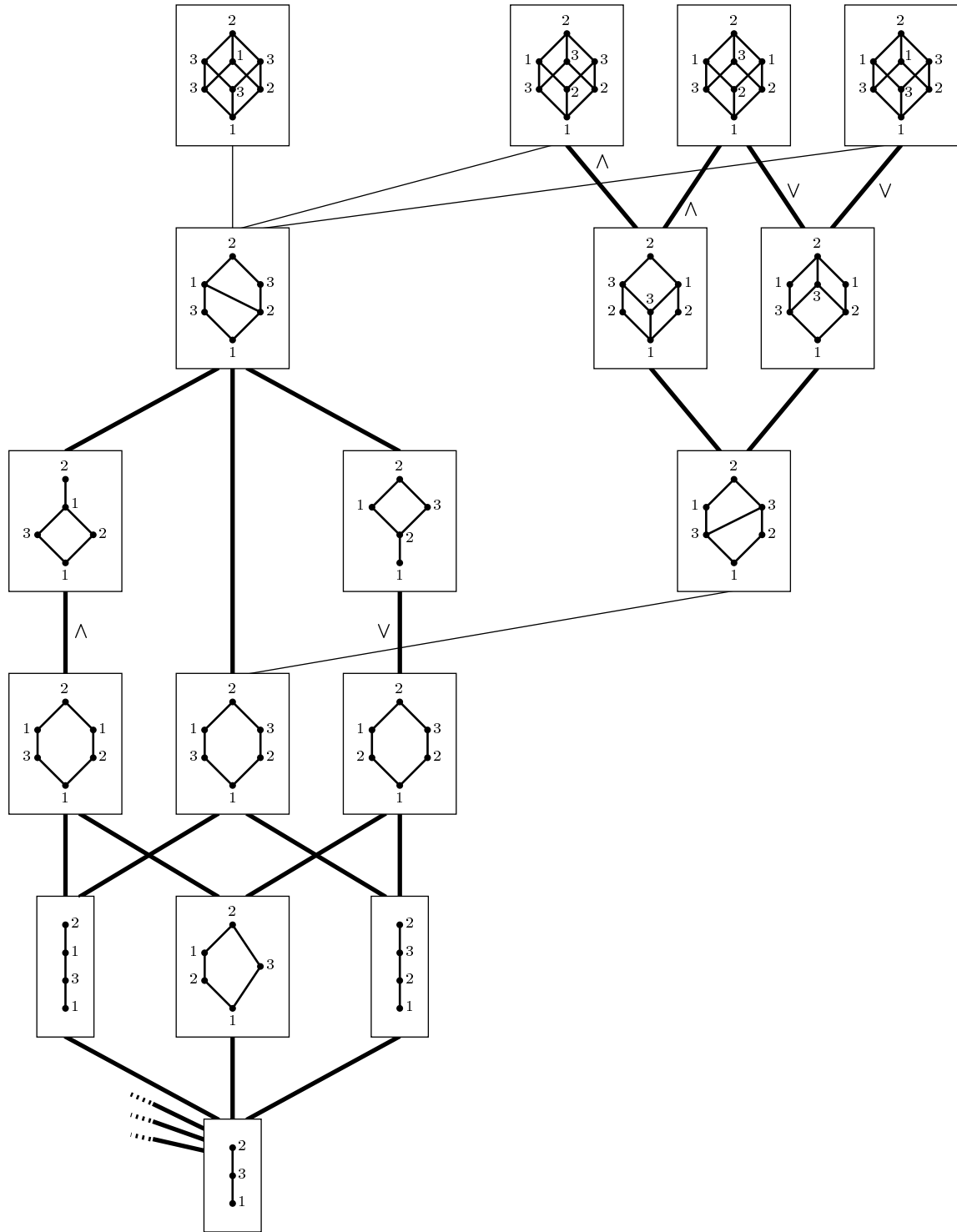

Fig. 3.12. Closer look at the middle part of the scheme in Figure 3.11



**Fig. 3.13.** Closer look at the right part of the scheme in Figure 3.11

$$f_m^i(j) = \begin{cases} 1, & \text{if } (j < i \text{ and } j \text{ is odd}) \text{ or } (j > i \text{ and } j \text{ is even}), \\ 2, & \text{if } (j < i \text{ and } j \text{ is even}) \text{ or } (j > i \text{ and } j \text{ is odd}), \\ 3, & \text{if } j = i. \end{cases}$$

It is easy to see that for all  $i, j \in G_m$  with  $i \neq j$  the 3-lattices  $(G_m, f_m^i)$  and  $(G_m, f_m^j)$  are incomparable with respect to  $\leq$ . Since the polynomial-time hierarchy is supposed to be strict, by the Embedding Theorem for NP with respect to  $k$ -chains (Theorem 3.44) we obtain that all generated partition classes are pairwise incomparable with respect to set inclusion.  $\square$

### 3.7 Machines That Accept Partitions

In this section we will see how the partitions of classes in the boolean hierarchy of  $k$ -partitions over NP can be accepted in a natural way by nondeterministic polynomial-time machines with a notion of acceptance which depends on the generating functions.

**Definition 3.54.** For  $m \in \mathbb{N}_+$ , a *polynomial-time  $m$ -machine*  $M$  is a nondeterministic polynomial-time machine producing on every computation path an element from the set  $\{0, 1, \dots, m\}$ . For an input  $x$  let

$$M(x) =_{\text{def}} \{ i \neq 0 \mid \text{there exists a path of } M \text{ on } x \text{ with result } i \}.$$

Obviously, a polynomial-time 1-machine is an ordinary nondeterministic polynomial-time machine. For  $i \in \{1, 2, \dots, m\}$  the sets

$$L_i(M) =_{\text{def}} \{ x \mid \text{there exists a path of } M \text{ on } x \text{ with result } i \}$$

are in NP and we obtain  $M(x) = \{i \mid x \in L_i(M)\}$  and  $c_{L_i(M)}(x) = c_{M(x)}(i)$  for all  $x$ .

**Definition 3.55.** For a function  $f : \mathcal{P}(\{1, 2, \dots, m\}) \rightarrow \{1, 2, \dots, k\}$  and a polynomial-time  $m$ -machine  $M$  let  $(M, f)$  be the  $k$ -partition defined by  $c_{(M,f)}(x) = f(M(x))$  for all  $x \in \Sigma^*$ .

Note that every function  $f : \mathcal{P}(\{1, 2, \dots, m\}) \rightarrow \{1, 2, \dots, k\}$  can also be considered to be the function  $f : \{1, 2\}^m \rightarrow \{1, 2, \dots, k\}$  and vice versa by the relationships  $f(a_1, \dots, a_m) = f(\{i \mid a_i = 1\})$  for  $a_1, \dots, a_m \in \{1, 2\}$  and

$$f(A) = f(c_A(1), \dots, c_A(m)) \quad \text{for } A \subseteq \{1, 2, \dots, m\}.$$

**Theorem 3.56.** Let  $m \in \mathbb{N}_+$  and  $f : \{1, 2\}^m \rightarrow \{1, 2, \dots, k\}$ .

$$\text{NP}(f) = \{ (M, f) \mid M \text{ is a polynomial-time } m\text{-machine} \}.$$

*Proof.*

$\subseteq$ : Let  $B_1, \dots, B_m$  be NP sets. There exist nondeterministic polynomial-time machines  $M_1, \dots, M_m$  such that  $M_i$  accepts  $B_i$  for  $i \in \{1, 2, \dots, m\}$ . Define  $M$  to be a nondeterministic polynomial-time machine which simulates  $M_1, \dots, M_m$  in parallel but when simulating  $M_i$  it outputs  $i$  rather than 1. Obviously, for all  $i \in \{1, 2, \dots, m\}$ ,  $L_i(M) = B_i$  and we conclude

$$\begin{aligned} c_{f(B_1, \dots, B_m)}(x) &= f(c_{B_1}(x), \dots, c_{B_m}(x)) = f(c_{L_1(M)}(x), \dots, c_{L_m(M)}(x)) \\ &= f(c_{M(x)}(1), \dots, c_{M(x)}(m)) = f(M(x)) = c_{(M,f)}(x). \end{aligned}$$



$\supseteq$ : Consider a polynomial-time  $m$ -machine  $M$  and conclude

$$\begin{aligned} c_{(M,f)}(x) &= f(M(x)) = f(c_{M(x)}(1), \dots, c_{M(x)}(m)) \\ &= f(c_{L_1(M)}(x), \dots, c_{L_m(M)}(x)) = c_{f(L_1(M), \dots, L_m(M))}(x). \end{aligned}$$

□

Finally, we discuss completeness for the partition classes  $\text{NP}(f)$ . We will see that it is easy to construct from an arbitrary NP-complete problem a problem which is complete for  $\text{NP}(f)$ .

We already used the notion of many-one reductions for partitions. We say that the  $k$ -partition  $A$  is polynomial-time many-one reducible to the  $k$ -partition  $B$  (for short  $A \leq_m^p B$ ) if and only if there exists a polynomial-time computable function  $g$  such that  $c_A(w) = c_B(g(w))$  for all  $w$ . Note that in the case  $k = 2$  this yields exactly the classical notion of polynomial-time many-one reducibility for sets.

From Theorem 3.56 we easily obtain the following:

**Proposition 3.57.** *Let  $k \geq 2$ . All classes in  $\text{BH}_k(\text{NP})$  and  $\text{BC}_k(\text{NP})$  are closed under  $\leq_m^p$ .*

A  $k$ -partition  $A$  is  $\leq_m^p$ -complete for a partition class  $\mathcal{C}$  (which is closed under  $\leq_m^p$ ) if and only if  $A \in \mathcal{C}$  and  $B \leq_m^p A$  for every  $k$ -partition  $B \in \mathcal{C}$ .

Recall that  $\pi_j^m$  denote projections of an encoded word  $w = \langle w_1, \dots, w_m \rangle$ . For a set  $A \subseteq \Sigma^*$  and a function  $f : \{1, 2\}^m \rightarrow \{1, 2, \dots, k\}$  define the  $k$ -partition  $A(f)$  by

$$c_{A(f)}(w) =_{\text{def}} f((c_A \circ \pi_1^m)(w)(c_A \circ \pi_2^m)(w) \dots (c_A \circ \pi_m^m)(w)) \quad \text{for all } w \in \Sigma^*.$$

**Theorem 3.58.** *Let  $f : \{1, 2\}^m \rightarrow \{1, 2, \dots, k\}$  with  $k \geq 2$ . Let  $A$  be  $\leq_m^p$ -complete for NP. Then  $A(f)$  is  $\leq_m^p$ -complete for  $\text{NP}(f)$ .*

*Proof.* Defining

$$A_i =_{\text{def}} \{ w \mid h_i(w) \in A \} \quad \text{for } i \in \{1, 2, \dots, m\}$$

we obtain  $A_i \in \text{NP}$ . For every  $w \in \Sigma^*$  we conclude

$$c_{A(f)}(w) = f((c_A \circ \pi_1^m)(w) \dots (c_A \circ \pi_m^m)(w)) = f(c_{A_1}(w) \dots c_{A_m}(w)) = c_f(A_1, \dots, A_m).$$

Consequently,  $A(f) = f(A_1, \dots, A_m) \in \text{NP}(f)$ .

Now take any  $B_1, \dots, B_m \in \text{NP}$ . Since  $A$  is  $\leq_m^p$ -complete for NP there exist polynomial-time computable functions  $g_1, \dots, g_m$  such that for every  $i \in \{1, 2, \dots, m\}$

$$w \in B_i \iff g_i(w) \in A.$$

Defining

$$g(w) =_{\text{def}} \langle g_1(w), \dots, g_m(w) \rangle \quad \text{for every } w \in \Sigma^*,$$

we can conclude

$$\begin{aligned} c_{f(B_1, \dots, B_m)}(w) &= f(c_{B_1}(w), \dots, c_{B_m}(w)) = f((c_A \circ g_1)(w), \dots, (c_A \circ g_m)(w)) \\ &= f((c_A \circ \pi_1^m \circ g)(w), \dots, (c_A \circ \pi_m^m \circ g)(w)) = c_{A(f)}(g(w)). \end{aligned}$$

Hence  $f(B_1, \dots, B_m) \leq_m^p A(f)$ . □

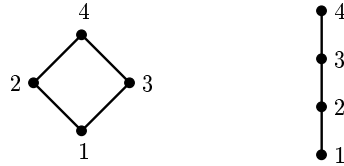

**Fig. 3.14.** Classes with complete partitions having components of same complexities

As a natural example of complete partition, consider the classification problem **ENTAILMENT** we have extensively discussed in the introductory chapter.

**Theorem 3.59.** *ENTAILMENT is  $\leq_m^p$ -complete for  $\text{NP}(f)$  where  $f : \{1, 2\}^2 \rightarrow \{1, 2, 3, 4\}$  is the function defined as  $f(1, 1) = 1$ ,  $f(1, 2) = 2$ ,  $f(2, 1) = 3$ , and  $f(2, 2) = 4$ .*

*Proof.* Obviously, **ENTAILMENT** is in  $\text{NP}(f)$ . Consider the partition **SATISFIABILITY**( $f$ ) which is  $\leq_m^p$ -complete for  $\text{NP}(f)$  by Theorem 3.58. More explicitly:

$$\begin{aligned} \text{SATISFIABILITY}(f)_1 &= \{ \langle F_1, F_2 \rangle \mid H_1 \in \text{SATISFIABILITY}, H_2 \in \text{SATISFIABILITY} \}, \\ \text{SATISFIABILITY}(f)_2 &= \{ \langle F_1, F_2 \rangle \mid H_1 \in \text{SATISFIABILITY}, H_2 \notin \text{SATISFIABILITY} \}, \\ \text{SATISFIABILITY}(f)_3 &= \{ \langle F_1, F_2 \rangle \mid H_1 \notin \text{SATISFIABILITY}, H_2 \in \text{SATISFIABILITY} \}, \\ \text{SATISFIABILITY}(f)_4 &= \{ \langle F_1, F_2 \rangle \mid H_1 \notin \text{SATISFIABILITY}, H_2 \notin \text{SATISFIABILITY} \}. \end{aligned}$$

We have to show that **SATISFIABILITY**( $f$ )  $\leq_m^p$  **ENTAILMENT**. This reduction is seen by the following algorithm. On input  $\langle F_1, F_2 \rangle$ , make the sets of variables in  $F_1$  and in  $F_2$  disjoint, take two new variables  $z_1$  and  $z_2$  not involved in  $F_1$  or  $F_2$ , and output  $\langle F'_1, F'_2 \rangle$  where  $F'_1 =_{\text{def}} z_1 \wedge F_1$  and  $F'_2 =_{\text{def}} z_2 \wedge F_2$ . Obviously, the algorithm runs in polynomial time. Moreover, we have that

$$\begin{aligned} F'_1 \models F'_2 &\iff F'_1 \notin \text{SATISFIABILITY} \\ F'_2 \models F'_1 &\iff F'_2 \notin \text{SATISFIABILITY}. \end{aligned}$$

Thus  $\langle F_1, F_2 \rangle \in \text{SATISFIABILITY}(f)_i \iff \langle F'_1, F'_2 \rangle \in \text{ENTAILMENT}_i$  for all  $i \in \{1, 2, 3, 4\}$ .  $\square$

Proving completeness results for entire partitions instead of only for the components allows finer distinguishing the complexity of classification problems. Obviously, completeness translates from the partition to the components: If the  $k$ -partition  $A$  is  $\leq_m^p$ -complete for the partition class  $\mathcal{C}$  then for each  $i \in \{1, \dots, k\}$ ,  $A_i$  is  $\leq_m^p$ -complete for the class  $\mathcal{C}_i$ . The converse direction need not to hold as can be seen for the partition classes that are described by the 4-lattices in Figure 3.14. Each class belongs to  $\text{BH}_4(\text{NP})$ , thus has complete partitions. **ENTAILMENT** is just a complete partition for the class generated by left 4-lattice in the figure. Let  $A$  be any  $\leq_m^p$ -complete partition for the class generated by the right 4-chain. Then for all  $i \in \{1, 2, 3, 4\}$  we have  $\text{ENTAILMENT}_i \equiv_m^p A_i$  but  $A$  does not reduce to **ENTAILMENT** unless  $\text{NP} = \text{coNP}$  as follows easily from Theorem 3.28.

## 4. Refining the Boolean Hierarchy of NP-Partitions

In the previous chapter the boolean hierarchy  $\text{BH}_k(\text{NP})$  of  $k$ -partitions over NP has been introduced for  $k \geq 2$  as a generalization of the boolean hierarchy of NP sets. It was shown that  $\text{BH}_k(\text{NP})$  coincides with the family of all partition classes generated by arbitrary  $k$ -lattices. In this chapter we will generalize this approach to the cases of arbitrary posets rather than lattices. As we will see this can be managed with the same, slightly modified notions as used in Chapter 3. We will show that all projectively closed partition classes having projection classes from the boolean hierarchy of sets are precisely captured by partition classes generated by finite labeled posets. That underlines the naturalness of the poset-approach. We further discuss the possibility of an Embedding Theorem with respect to labeled posets and prove a relativized version of it.

### 4.1 Partition Classes Defined by Posets

In order to define how labeled posets generate partition classes we follow completely the line offered in Section 3.2. Most results translate from lattices to posets though by proving them anew.

Let  $\mathcal{K}$  be a class with  $\emptyset, M \in \mathcal{K}$  and  $\mathcal{K}$  is closed under union and intersection.

**Definition 4.1.** Let  $G$  be a poset.

1. A mapping  $S : G \rightarrow \mathcal{K}$  is said to be a  $\mathcal{K}$ -homomorphism on  $G$  if and only if

- a)  $\bigcup_{a \in G} S(a) = M$  and

- b)  $S(a) \cap S(b) = \bigcup_{c \leq a, c \leq b} S(c)$  for all  $a, b \in G$ .

2. For any  $\mathcal{K}$ -homomorphism  $S$  on  $G$  and  $a \in G$ , let

$$T_S(a) =_{\text{def}} S(a) \setminus \bigcup_{b < a} S(b).$$

Note that in the case of a lattice  $G$  the above notion of  $\mathcal{K}$ -homomorphism on  $G$  coincides with the one made for lattices, i.e.,  $S(1_G) = M$  and  $S(a) \cap S(b) = S(a \wedge b)$ .

**Lemma 4.2.** Let  $G$  be a poset, and let  $S$  be a  $\mathcal{K}$ -homomorphism on  $G$ .

1.  $T_S(a) \in \mathcal{K} \wedge \text{co}\mathcal{K}$  for every  $a \in G$ .
2. If  $a \leq b$  then  $S(a) \subseteq S(b)$  for every  $a, b \in G$ .

3.  $S(a) = \bigcup_{b \leq a} T_S(b)$  for every  $a \in G$ .
4. The set of all  $T_S(a)$  for  $a \in G$  yields a partition of  $M$ .

*Proof.*

1. The same as Lemma 3.7.1.
2. If  $a \leq b$  then  $S(b) = S(b) \cap S(b) = \bigcup_{c \leq b} S(c) \supseteq S(a)$ .
3. The direction “ $\supseteq$ ” is obvious since  $T_S(b) \subseteq S(b) \subseteq S(a)$  for  $b \leq a$ . The converse inclusion can be verified by induction on  $<$ . Obviously,  $S(a) = T_S(a)$  for minimal  $a \in G$ . For non-minimal  $a \in G$  we obtain

$$S(a) = T_S(a) \cup \bigcup_{b < a} S(b) = T_S(a) \cup \bigcup_{b < a} \bigcup_{c \leq b} T_S(c) = T_S(a) \cup \bigcup_{c < a} T_S(c).$$

4. We have to show that every  $x \in M$  is contained in exactly one  $T_S(a)$ . Proving the existence of such an  $a \in G$ , define

$$H_x =_{\text{def}} \{ a \mid x \in S(a) \}$$

which is non-empty since  $\bigcup_{a \in G} S(a) = M$ . For  $a, b \in H_x$ , i.e.,  $x \in S(a) \cap S(b) = \bigcup_{c \leq a, c \leq b} S(c)$  there is a  $c \in G$  such that  $c \leq a$ ,  $c \leq b$ , and  $c \in H_x$ . Hence the set  $H_x$  has a least element  $d_x$ . Obviously,  $x \in T_S(d_x) = S(d_x) \setminus \bigcup_{c < d_x} S(c)$ . On the other hand, assume  $x \in T_S(a)$  for some  $a \in G$ . Then  $x \in S(a)$  which implies  $a \in H_x$  and  $d_x \leq a$ . Because of  $x \in T_S(a) = S(a) \setminus \bigcup_{b < a} S(b)$  we conclude  $d_x \not\leq a$  which means  $d_x = a$ .  $\square$

Lemma 4.2 provides that the following definitions are sound.

**Definition 4.3.** Let  $(G, f)$  be a  $k$ -poset. Let  $k \geq 2$ .

1. For a  $\mathcal{K}$ -homomorphism  $S$  on  $G$ , the  $k$ -partition defined by  $(G, f)$  and  $S$  is given by

$$(G, f, S) =_{\text{def}} \left( \bigcup_{f(a)=1} T_S(a), \dots, \bigcup_{f(a)=k} T_S(a) \right).$$

2. The class of  $k$ -partitions defined by the  $k$ -poset  $(G, f)$  is given by

$$\mathcal{K}(G, f) =_{\text{def}} \{ (G, f, S) \mid S \text{ is } \mathcal{K}\text{-homomorphism on } G \}.$$

**Example 4.4.** Consider the 4-poset  $(G, f)$  pictured in Figure 4.1. We want to verify that GRAPH EMBEDDING is contained in  $\text{NP}(G, f)$ . Define a mapping  $S$  on  $\{a, b, c, d, e\}$  as follows:

$$\begin{aligned} S(a) &=_{\text{def}} \{ \langle G, G' \rangle \mid G = (V, E), G' = (V', E') \text{ graphs, } G \hookrightarrow G', G' \hookrightarrow G \}, \\ S(b) &=_{\text{def}} \{ \langle G, G' \rangle \mid G = (V, E), G' = (V', E') \text{ graphs, } G \hookrightarrow G' \}, \\ S(c) &=_{\text{def}} \{ \langle G, G' \rangle \mid G = (V, E), G' = (V', E') \text{ graphs, } G' \hookrightarrow G \}, \\ S(d) &=_{\text{def}} \{ \langle G, G' \rangle \mid G = (V, E), G' = (V', E') \text{ graphs, } \|V\| \leq \|V'\| \}, \\ S(e) &=_{\text{def}} \{ \langle G, G' \rangle \mid G = (V, E), G' = (V', E') \text{ graphs, } \|V\| > \|V'\| \} \cup S(a). \end{aligned}$$

Clearly  $S$  maps to NP. We easily obtain  $S(d) \cup S(e) = \Sigma^*$  and  $S(a) = S(b) \cap S(c) = S(d) \cap S(e)$ . Hence,  $S$  is an NP-homomorphism on  $G$ . We further observe that GRAPH EMBEDDING =  $(G, f, S)$ . Thus GRAPH EMBEDDING is in  $\text{NP}(G, f)$ .

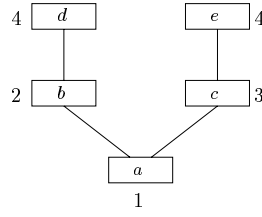

Fig. 4.1. The 4-poset for GRAPH EMBEDDING

**Definition 4.5.** The family  $\text{RBH}_k(\mathcal{K}) =_{\text{def}} \{\mathcal{K}(G, f) \mid (G, f) \text{ is a } k\text{-poset}\}$  is the *refined boolean hierarchy of  $k$ -partitions over  $\mathcal{K}$* .

The following propositions relate the extended boolean hierarchy to the boolean hierarchy.

**Proposition 4.6.**  $\text{BH}_k(\mathcal{K}) \subseteq \text{RBH}_k(\mathcal{K})$  for every  $k \geq 2$ .

*Proof.* Immediate from Corollary 3.12.  $\square$

**Proposition 4.7.** Let  $\mathcal{K}$  be not closed under complements, and let  $k \geq 2$ . Then there exists a partition class in  $\text{RBH}_k(\mathcal{K})$  which does not belong to  $\text{BH}_k(\mathcal{K})$ .

*Proof.* It is easily seen that the class  $(\mathcal{K}, \dots, \mathcal{K})$  of  $k$ -partitions is defined by a  $k$ -elementary  $k$ -antichain with  $k$  different labels. Assume there is an  $f : \{1, 2\}^m \rightarrow \{1, 2, \dots, k\}$  with  $(\mathcal{K}, \dots, \mathcal{K}) = \mathcal{K}(f)$ . Clearly,  $f$  is surjective. Let  $z \in \{1, 2\}^m$  be minimal with  $f(1^m) \neq f(z)$ . For an arbitrary set  $A \in \mathcal{K}$  define the  $\mathcal{K}$ -homomorphism  $S$  on  $(\{1, 2\}^m, \leq)$  as  $S(a) = A$  if  $z \not\leq a$ , and  $S(a) = M$  otherwise. Thus,  $(\{1, 2\}^m, f, S)_{f(z)} = \overline{A}$ . Hence,  $\overline{A} \in \mathcal{K}$  and consequently,  $A \in \text{co}\mathcal{K}$ , a contradiction.  $\square$

**Proposition 4.8.** Let  $(G, f)$  be a  $k$ -poset with  $f : G \rightarrow \{1, 2, \dots, k\}$  surjective.

1.  $(\mathcal{K}, \dots, \mathcal{K}) \subseteq \mathcal{K}(G, f) \subseteq (\text{BC}(\mathcal{K}), \dots, \text{BC}(\mathcal{K})) = \text{BC}_k(\mathcal{K})$ .
2. If  $\mathcal{K}$  is closed under complements then  $\mathcal{K}(G, f) = (\mathcal{K}, \dots, \mathcal{K})$ .

*Proof.*

1. We first show that  $(\mathcal{K}, \dots, \mathcal{K}) \subseteq \mathcal{K}(f)$ . Let  $A = (A_1, \dots, A_k) \in (\mathcal{K}, \dots, \mathcal{K})$ . For every  $i \in \{1, 2, \dots, k\}$  fix some  $b_i \in G$  such that  $f(b_i) = i$ . For  $a \in G$  define

$$S(a) =_{\text{def}} \bigcup_{b_i \leq a} A_i.$$

The function  $S : G \rightarrow \{1, 2, \dots, k\}$  is a  $\mathcal{K}$ -homomorphism on  $G$  because of

$$\bigcup_{a \in G} S(a) \supseteq \bigcup_{i=1}^k S(b_i) \supseteq \bigcup_{i=1}^k A_i = M$$

and

$$S(a) \cap S(b) = \left( \bigcup_{b_i \leq a} A_i \right) \cap \left( \bigcup_{b_i \leq b} A_i \right) = \bigcup_{b_i \leq a, b} A_i = \bigcup_{c \leq a, b} \bigcup_{b_i \leq c} A_i = \bigcup_{c \leq a, b} S(c).$$

For every  $i \in \{1, 2, \dots, k\}$  we conclude

$$\begin{aligned} (G, f, S)_i &= \bigcup_{f(a)=i} T_S(a) = \bigcup_{f(a)=i} \left( S(a) \setminus \bigcup_{b < a} S(b) \right) \\ &= \bigcup_{f(a)=i} \left[ \left( \bigcup_{b_j \leq a} A_j \right) \setminus \left( \bigcup_{b_j < a} A_j \right) \right] = \bigcup_{f(a)=i} \bigcup_{b_j=a} A_j = A_i. \end{aligned}$$

Hence  $A = (A_1, \dots, A_k) = (G, f, S) \in \mathcal{K}(G, f)$ .

To show  $\mathcal{K}(G, f) \subseteq (\text{BC}(\mathcal{K}), \dots, \text{BC}(\mathcal{K}))$  let  $S$  be a  $\mathcal{K}$ -homomorphism on  $G$ . For  $i \in \{1, 2, \dots, k\}$  we obtain  $(G, f, S)_i = \bigcup_{f(a)=i} T_S(a)$ . By Proposition 4.2.1 we easily get  $(G, f, S)_i \in \mathcal{K}(2 \cdot \|f^{-1}(i)\|)$ .

$\text{BC}_k(\mathcal{K}) = (\text{BC}(\mathcal{K}), \dots, \text{BC}(\mathcal{K}))$  is from Proposition 3.2.

2. Immediate consequence of the first one. □

As in the case of the boolean hierarchy of  $k$ -partitions it would be very useful to decide whether  $\mathcal{K}(G, f) \subseteq \mathcal{K}(G', f')$  for  $k$ -posets  $(G, f)$  and  $(G', f')$  by only looking at the defining posets. The relation  $\leq$  we have used for lattices has already been defined for posets (Definition 3.13). We are able to state an Embedding Lemma for posets. So Lemma 3.14 is simply a special case of this more general result.

**Lemma 4.9. (Embedding Lemma.)** *Let  $(G, f)$  and  $(G', f')$  be  $k$ -posets. Then, if  $(G, f) \leq (G', f')$ , then  $\mathcal{K}(G, f) \subseteq \mathcal{K}(G', f')$ .*

*Proof.* Let  $\varphi : G \rightarrow G'$  be a monotonic mapping such that  $f(a) = f'(\varphi(a))$  for every  $a \in G$ . For a  $\mathcal{K}$ -homomorphism  $S$  on  $G$  define the mapping  $S' : G' \rightarrow \mathcal{K}$  for all  $a \in G'$  by

$$S'(a) =_{\text{def}} \bigcup_{\varphi(b) \leq' a} S(b).$$

It is sufficient to prove that  $S'$  is a  $\mathcal{K}$ -homomorphism on  $G'$ , i.e., that

1.  $\bigcup_{a \in G'} S'(a) = M$  and
2.  $S'(a) \cap S'(b) = \bigcup_{c \leq' a, b} S'(c)$  for all  $a, b \in G'$ ,
3.  $T_S(a) \subseteq T_{S'}(\varphi(a))$  for all  $a \in G$ .

This can be shown as follows:

1. We conclude  $\bigcup_{a \in G'} S'(a) = \bigcup_{a \in G'} \bigcup_{\varphi(b) \leq' a} S(b) \supseteq \bigcup_{b \in G} S(b) = M$ .
2. The inclusion “ $\supseteq$ ” is valid because of the monotonicity of  $S'$ . For the converse inclusion consider  $x \in S'(a) \cap S'(b)$ . There exist  $c, d \in G$  such that  $\varphi(c) \leq' a$ ,  $\varphi(d) \leq' b$ ,  $x \in S(c) \cap S(d) = \bigcup_{e \leq c, d} S(e)$ . Hence there exists an  $e_0 \leq c, d$  such that  $x \in S(e_0)$ . We obtain  $x \in S'(\varphi(e_0))$  and  $\varphi(e_0) \leq' \varphi(c) \leq' a$  and  $\varphi(e_0) \leq' \varphi(d) \leq' b$ .
3. For  $a \in G$  and  $x \in T_S(a)$  we obtain  $x \in S(a) \subseteq S'(\varphi(a))$ . Assume that  $x \notin T_{S'}(\varphi(a))$ . Then there exists a  $c < \varphi(a)$  such that  $x \in S'(c)$ . Consequently, there exists a  $b \in G$  such that  $\varphi(b) \leq' c$  and  $x \in S(b)$ . Hence  $x \in S(a) \cap S(b) = \bigcup_{d \leq a, b} S(d)$ . Hence there exists a  $d_0 \leq a, b$  such that  $x \in S(d_0)$ . Because of  $x \in T_S(a)$  we get  $d_0 \not\leq a$  and thus  $a = d_0$ . We conclude  $\varphi(a) = \varphi(d_0) \leq' \varphi(b) \leq' c$ , a contradiction. □

Possibilities to invert the Embedding Lemma for posets will be examined in Section 4.4. The next proposition indicates that there is a canonical way to represent  $\text{RBH}_k(\mathcal{K})$ .

**Proposition 4.10.** *Let  $(G, f)$  be a  $k$ -poset. Then there is a partial function  $f' : \{1, 2\}^m \rightarrow \{1, 2, \dots, k\}$  such that  $(G, f) \equiv (D_{f'}, f')$  and consequently,  $\mathcal{K}(G, f) = \mathcal{K}(D_{f'}, f')$ .*

*Proof.* For all  $a \in G$ , consider sets  $L_a = \{b \in G \mid b \leq a\}$ . It holds  $a \leq b$  if and only if  $L_a \subseteq L_b$ . Define a partial function  $f' : \mathcal{P}(G) \rightarrow \{1, 2, \dots, k\}$  by

$$D_{f'} =_{\text{def}} \{ L_a \mid a \in G \} \quad \text{and} \quad f'(L_a) =_{\text{def}} f(a).$$

Clearly,  $(G, f) \equiv (D_{f'}, f')$  and  $(\mathcal{P}(G), \subseteq)$  is isomorphic to  $(\{1, 2\}^{\|G\|}, \leq)$ . □

## 4.2 An Alternative Approach

In Section 4.1 it has been described how to define classes of  $k$ -partitions by posets. This has generalized the case of lattices. In this section we will make another generalization of the lattice approach which results in the same classes of  $k$ -partitions as obtained in the poset approach.

Let  $\mathcal{K}$  be such that  $\emptyset, M \in \mathcal{K}$  and  $\mathcal{K}$  is closed under union and intersection.

**Definition 4.11.** Let  $G$  be a lattice and let  $H \subset G$ .

1. A mapping  $S : G \rightarrow \mathcal{K}$  is said to be a  $\mathcal{K}$ -homomorphism on  $(G, H)$  if and only if
  - a)  $S(1_G) = M$ ,
  - b)  $S(a \wedge b) = S(a) \cap S(b)$  for all  $a, b \in G$ ,
  - c)  $S(a) = \bigcup_{b < a} S(b)$  for all  $a \in H$ .

2. For any  $\mathcal{K}$ -homomorphism  $S$  on  $(G, H)$  and for all  $a \in G$ , let

$$T_S(a) =_{\text{def}} S(a) \setminus \bigcup_{b < a} S(b).$$

As immediate consequences of this definition we obtain

**Proposition 4.12.** *Let  $S$  be a  $\mathcal{K}$ -homomorphism on  $(G, H)$  for a lattice  $G$  and  $H \subset G$ .*

1.  $S$  is a  $\mathcal{K}$ -homomorphism on  $G$ .
2.  $T_S(a) = \emptyset$  for all  $a \in H$ .

**Proposition 4.13.** *Let  $S$  be a  $\mathcal{K}$ -homomorphism on a lattice  $G$  and let  $H \subset G$ . If  $T_S(a) = \emptyset$  for all  $a \in H$ , then  $S$  is a  $\mathcal{K}$ -homomorphism on  $(G, H)$ .*

Consequently we can apply all definitions made for  $\mathcal{K}$ -homomorphisms on  $G$  also to  $\mathcal{K}$ -homomorphisms on  $(G, H)$ . So we are able to define classes of  $k$ -partitions.

**Definition 4.14.** For a  $k$ -lattice  $(G, f)$  and a set  $H \subset G$  define

$$\mathcal{K}(G, H, f) =_{\text{def}} \{(G, f, S) \mid S \text{ is a } \mathcal{K}\text{-homomorphism on } (G, H)\}.$$

It turns out that every such class  $\mathcal{K}(G, H, f)$  is also of the form  $\mathcal{K}(G, f)$  where  $(G, f)$  is a  $k$ -poset and vice versa. Furthermore, we can equivalently consider boolean  $k$ -lattices  $(G, f)$  and  $H \subset G$ .

In the following, as a shorthand, we identify a function  $f$  with any restriction of  $f$  to a smaller domain, i.e., with  $f|_A$  for  $A \subseteq D_f$ .

**Lemma 4.15.** *Let  $(G, f)$  be a  $k$ -lattice and let  $S$  be a  $\mathcal{K}$ -homomorphism on  $(G, H)$  for any set  $H \subset G$ . Then  $S$  is also  $\mathcal{K}$ -homomorphism on the poset  $G \setminus H$ . Moreover it holds that  $(G, f, S) = (G \setminus H, f, S)$ .*

*Proof.* Let  $G'$  denote the poset  $G \setminus H$ . Due to Proposition 4.12 it is enough to show the first statement. That is we have to prove that

1.  $\bigcup_{a \in G'} S(a) = M$ ,
2.  $S(a) \cap S(b) = \bigcup_{\substack{c \leq a, c \leq b \\ c \in G'}} S(c)$  for all  $a, b \in G'$ .

This can be seen as follows:

1. We conclude  $\bigcup_{a \in G'} S(a) \supseteq \bigcup_{a \in G'} T_S(a) = M$ .
2. Let  $a, b \in G'$ . It holds  $S(a) \cap S(b) = S(a \wedge b)$ . If  $a \wedge b \notin H$  then the statement holds obviously. Now, let  $a \wedge b \in H$ . Then

$$S(a) \cap S(b) = S(a \wedge b) = \bigcup_{c < a \wedge b} S(c) = \bigcup_{c < a \wedge b, c \in G'} S(c).$$

□

For a partial function  $f : \{1, 2\}^m \rightarrow \{1, 2, \dots, k\}$ , let  $H_f$  denote the set of all arguments where  $f$  is not defined.

**Theorem 4.16.** *Let  $f : \{1, 2\}^m \rightarrow \{1, 2, \dots, k\}$  be a partial function with non-empty domain. Then  $\mathcal{K}(D_f, f) = \mathcal{K}(\{1, 2\}^m, H_f, f')$  where  $f'$  is an arbitrary total extension of  $f$  to  $\{1, 2\}^m$  with function values in  $\{1, 2, \dots, k\}$ .*

*Proof.* The inclusion “ $\supseteq$ ” follows from Lemma 4.15. For the converse inclusion let  $S$  be a  $\mathcal{K}$ -homomorphism on  $(\{1, 2\}^m, H_f)$ . Then define a mapping  $S' : \{1, 2\}^m \rightarrow \mathcal{K}$  for all  $a \in \{1, 2\}^m$  as

$$S'(a) =_{\text{def}} \begin{cases} S(a) & \text{if } a \in D_f, \\ \bigcup_{b < a, b \in D_f} S(b) & \text{if } a \in H_f. \end{cases}$$

Observe that  $S'$  is monotonic. First we have to make sure that  $S'$  is a  $\mathcal{K}$ -homomorphism on  $(\{1, 2\}^m, H_f)$ , i.e., it holds that

1.  $\bigcup_{a \in \{1, 2\}^m} S'(a) = M$ ,
2.  $S'(a) \cap S'(b) = S'(a \wedge b)$  for all  $a, b \in \{1, 2\}^m$ ,
3.  $S'(a) = \bigcup_{b < a} S'(b)$  for all  $a \in H_f$ .



This is seen as follows:

1. We conclude  $\bigcup_{a \in \{1,2\}^m} S'(a) \supseteq \bigcup_{a \in D_f} S(a) = M$ .
2. The inclusions “ $\supseteq$ ” are immediate due to the monotonicity of  $S'$ . Conversely, let  $x \in S'(a) \cap S'(b')$ . Thus there exist  $c, d \in D_f$  such that  $c < a$ ,  $d < b$ , and  $x \in S(c) \cap S(d)$ . Hence there is an  $e \in D_f$  with  $e \leq c \wedge d$  and  $x \in S(e) = S'(e)$ . We get  $e \leq a \wedge b$  and consequently  $x \in S'(a \wedge b)$ .
3. Again the inclusions “ $\supseteq$ ” follow directly from the monotonicity of  $S'$ . For the other inclusion let  $x \in S'(a)$  for  $a \in H$ . That is there exists a  $b \in D_f$  with  $b < a$  and  $x \in S(b) = S'(b)$ . Hence,  $x \in \bigcup_{b < a} S'(b)$ .

In order to prove  $(D_f, f, S) = (\{1, 2\}^m, f', S')$  it suffices to show  $T_{S'}(a) \subseteq T_S(a)$  for all  $a \notin H_f$ . Let  $x \in T_{S'}(a)$ . Then  $x \in S'(a) = S(a)$ . Assuming  $x \notin T_S(a)$  leads to a  $b \in D_f$  with  $b < a$  and  $x \in S(b) = S'(b)$ . Hence  $x \notin T_S(a)$  what is a contradiction.  $\square$

**Corollary 4.17.**

$$\begin{aligned} \text{RBH}_k(\mathcal{K}) &= \{ \mathcal{K}(G, H, f) \mid (G, f) \text{ is a boolean } k\text{-lattice and } H \subset G \} \\ &= \{ \mathcal{K}(G, H, f) \mid (G, f) \text{ is a } k\text{-lattice and } H \subset G \}. \end{aligned}$$

*Proof.* Follows from Proposition 4.10, Theorem 4.16, and Lemma 4.15.  $\square$

**Corollary 4.18.** *Let  $f : \{1, 2\}^m \rightarrow \{1, 2, \dots, k\}$  be a partial function with non-empty domain. Then a  $k$ -partition  $A$  belongs to the partition class  $\mathcal{K}(D_f, f)$  if and only if there are sets  $B_1, \dots, B_m \in \mathcal{K}$  such that for all  $x \in M$ ,*

1.  $(c_{B_1}(x), \dots, c_{B_m}(x)) \in D_f$  and
2.  $c_A(x) = f(c_{B_1}(x), \dots, c_{B_m}(x))$ .

Again it is useful to have the possibility comparing structures  $(G, H, f)$  and  $(G', H', f')$ .

**Definition 4.19.** Let  $(G, f)$  and  $(G', f')$  be  $k$ -lattices, let  $H \subset G$  and  $H' \subset G'$ .

1.  $(G, H, f) \leq (G', H', f')$  if and only if there is a monotonic mapping  $\varphi : G \rightarrow G'$  such that
  - a)  $\varphi(G \setminus H) \subseteq (G' \setminus H')$  and
  - b)  $f(x) = f'(\varphi(x))$  for all  $x \in G \setminus H$ .
2.  $(G, H, f) \equiv (G', H', f')$  if and only if  $(G, H, f) \leq (G', H', f')$  and  $(G', H', f') \leq (G, H, f)$ .

This relation is compatible to the one made for  $k$ -posets.

**Proposition 4.20.** *Let  $(G, f)$  and  $(G', f')$  be  $k$ -lattices, let  $H \subset G$  and  $H' \subset G'$ . Then  $(G, H, f) \leq (G', H', f')$  if and only if  $(G \setminus H, f) \leq (G' \setminus H', f')$ .*

*Proof.* The direction “ $\Rightarrow$ ” is obvious. For “ $\Leftarrow$ ” let  $\varphi$  be a monotonic mapping witnessing  $(G \setminus H, f) \leq (G' \setminus H', f')$ . For  $a \in G$  define

$$L_a =_{\text{def}} \{ b \in G \setminus H \mid b \geq a \} \quad \text{and} \quad \psi(a) = \bigwedge_{b \in L_a} \varphi(b).$$

Observe  $\psi(a) = \varphi(a)$  for all  $a \in G \setminus H$ . Moreover, if  $a \leq b$ , then  $L_b \subseteq L_a$ , thus  $\psi(a) \leq \psi(b)$ . Hence,  $(G, H, f) \leq (G', H', f')$ .  $\square$

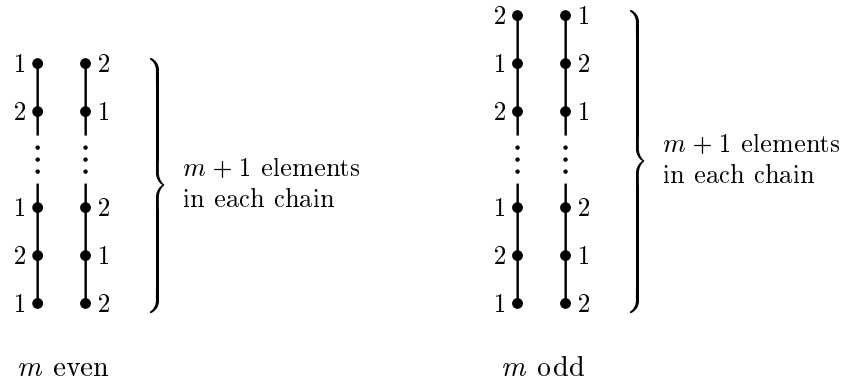

Fig. 4.2. The 2-poset  $\mathfrak{D}_m$  for  $m \in \mathbb{N}$

**Corollary 4.21. (Embedding Lemma.)** *Let  $(G, f)$  and  $(G', f')$  be  $k$ -lattices, let  $H \subset G$  and  $H' \subset G'$ . If  $(G, H, f) \leq (G', H', f')$  then  $\mathcal{K}(G, H, f) \subseteq \mathcal{K}(G', H', f')$ .*

*Proof.* If  $(G, H, f) \leq (G', H', f')$  then  $(G \setminus H, f) \leq (G' \setminus H', f')$ . Hence by Lemma 4.15 and the Embedding Lemma for posets,  $\mathcal{K}(G, H, f) = \mathcal{K}(G \setminus H, f) \subseteq \mathcal{K}(G' \setminus H', f') = \mathcal{K}(G', H', f')$ . Note that the restricted versions of  $f$  and  $f'$  need not be surjective.  $\square$

### 4.3 Characterizing the Projective Closure

We have been faced repeatedly with the situation that (probably) different partition classes have the same projection classes. The projectively closed classes are the greatest (with respect to set-inclusion) among these. In this section we determine important partition classes of  $\text{RBH}_k(\mathcal{K})$  that are projectively closed. We prove the rather surprising result that each projectively closed class with projection classes from the boolean hierarchy of sets over  $\mathcal{K}$  is generated by labeled posets. We describe a method for calculating these posets.

Let  $\mathcal{K}$  be such that  $\emptyset, M \in \mathcal{K}$  and  $\mathcal{K}$  is closed under intersection and union.

#### 4.3.1 Projection Classes

From Proposition 4.8 we know that all components of partition classes generated by  $k$ -posets over a class  $\mathcal{K}$  belong to the (two-valued) boolean closure  $\text{BC}(\mathcal{K})$  of  $\mathcal{K}$ . Theorem 4.23 tells us what exactly is the complexity of the components. We need the following lemma which is also interesting in its own. For all  $m \in \mathbb{N}$  let  $\mathfrak{D}_m$  be the 2-poset represented in Figure 4.2.

**Lemma 4.22.**  $\mathcal{K}(\mathfrak{D}_m) = (\mathcal{K} \cap \text{co}\mathcal{K}) \oplus \mathcal{K}(m)$  for all  $m \in \mathbb{N}$ .

*Proof.* Let  $l_0, \dots, l_m$  be the (ascendingly ordered) elements belonging to the left chain in  $\mathfrak{D}_m$  and let  $r_0, \dots, r_m$  be the (ascendingly ordered) elements belonging to the right chain in  $\mathfrak{D}_m$ .

$\subseteq$ : Let  $S$  be a  $\mathcal{K}$ -homomorphism on  $\{l_0, \dots, l_m, r_0, \dots, r_m\}$ . Thus,  $S(l_m) \cap S(r_m) = \emptyset$  and  $S(l_m) \cup S(r_m) = M$ . Hence,  $S(l_m) = \overline{S(r_m)}$ . Consequently,  $S$  maps  $l_m$  and  $r_m$  to sets in  $\mathcal{K} \cap \text{co}\mathcal{K}$ . Moreover,  $S(l_0) \subseteq \dots \subseteq S(l_m)$  and  $S(r_0) \subseteq \dots \subseteq S(r_m)$ . By induction the following equations can be easily verified. Let  $2n \leq m$ .

$$\bigtriangleup_{j=0}^{2n-1} (S(l_j) \cup S(r_j)) = \bigcup_{j=0}^{n-1} [(S(l_{2j+1}) \setminus S(l_{2j})) \cup (S(r_{2j+1}) \setminus S(r_{2j}))], \quad (4.1)$$

$$\begin{aligned} \bigtriangleup_{j=0}^{2n} (S(l_j) \cup S(r_j)) &= S(l_0) \cup S(r_0) \cup \\ &\cup \bigcup_{j=1}^n [(S(l_{2j}) \setminus S(l_{2j-1})) \cup (S(r_{2j}) \setminus S(r_{2j-1}))]. \end{aligned} \quad (4.2)$$

We have two cases.

- *Case*  $m = 2n$ . Consider the set  $B_S$  defined as

$$B_S =_{\text{def}} S(l_m) \triangle \left( \bigtriangleup_{j=0}^{m-1} (S(l_j) \cup S(r_j)) \right).$$

Clearly,  $B_S$  is in  $(\mathcal{K} \cap \text{co}\mathcal{K}) \oplus \mathcal{K}(m)$ . Eliminating the first symmetric difference we get

$$B_S = \underbrace{\left[ S(l_m) \setminus \bigtriangleup_{j=0}^{m-1} (S(l_j) \cup S(r_j)) \right]}_{(1)} \cup \underbrace{\left[ \left( \bigtriangleup_{j=0}^{m-1} (S(l_j) \cup S(r_j)) \right) \setminus S(l_m) \right]}_{(2)}.$$

Using Equation (4.1) we further calculate for Term (1)

$$\begin{aligned} &S(l_m) \setminus \bigtriangleup_{j=0}^{2n-1} (S(l_j) \cup S(r_j)) \\ &= S(l_m) \setminus \bigcup_{j=0}^{n-1} [(S(l_{2j+1}) \setminus S(l_{2j})) \cup (S(r_{2j+1}) \setminus S(r_{2j}))] \\ &= S(l_m) \setminus \bigcup_{j=0}^{n-1} (S(l_{2j+1}) \setminus S(l_{2j})) = \bigcap_{j=0}^{n-1} [(S(l_m) \setminus S(l_{2j+1})) \cup S(l_{2j})] \\ &= S(l_0) \cup \bigcup_{j=1}^n (S(l_{2j}) \setminus S(l_{2j-1})). \end{aligned} \quad (4.3)$$

For Term (2) we can calculate using Equation (4.2)

$$\begin{aligned} &\left( \bigtriangleup_{j=0}^{2n-1} (S(l_j) \cup S(r_j)) \right) \setminus S(l_m) \\ &= \left( \bigcup_{j=0}^{n-1} [(S(l_{2j+1}) \setminus S(l_{2j})) \cup (S(r_{2j+1}) \setminus S(r_{2j}))] \right) \cap S(r_m) \\ &= \bigcup_{j=0}^{n-1} S(r_{2j+1}) \setminus S(r_{2j}). \end{aligned} \quad (4.4)$$

Putting together Equations (4.3) and (4.4) yield  $B_S = (\mathfrak{D}_m, S)_1$ .

- *Case  $m = 2n + 1$ .* Similar to the first case but now by defining  $B_S$  as

$$B_S =_{\text{def}} S(r_m) \Delta \left( \begin{array}{c} m-1 \\ \Delta \\ j=0 \end{array} (S(l_j) \cup S(r_j)) \right).$$

$\supseteq$ : Let  $A \in (\mathcal{K} \cap \text{co}\mathcal{K}) \oplus \mathcal{K}(m)$ . That is  $A = B \Delta C_1 \Delta \cdots \Delta C_m$  for appropriate  $B \in \mathcal{K} \cap \text{co}\mathcal{K}$ ,  $C_i \in \mathcal{K}$ , and  $C_1 \subseteq \cdots \subseteq C_m$ . Again we distinguish between odd and even numbers.

- *Case  $m = 2n$ .* Define a mapping  $S : \{l_0, \dots, l_m, r_0, \dots, r_m\} \rightarrow \mathcal{K}$  as follows:

$$\begin{aligned} S(l_m) &= B, & S(r_m) &= \overline{B}, \\ S(l_j) &= B \cap C_{j+1} \text{ for } j < m, & S(r_j) &= \overline{B} \cap C_{j+1} \text{ for } j < m. \end{aligned}$$

Obviously,  $S$  is a  $\mathcal{K}$ -homomorphism on  $\{l_0, \dots, l_m, r_0, \dots, r_m\}$ . Furthermore using Equations (4.1) and (4.2) we obtain

$$\begin{aligned} &(\mathfrak{D}_m, S)_1 \\ &= S(l_0) \cup (S(r_1) \setminus S(r_0)) \cup (S(l_2) \setminus S(l_1)) \cup \cdots \cup (S(l_m) \setminus S(l_{m-1})) \\ &= (B \cap C_1) \cup (\overline{B} \cap (C_2 \setminus C_1)) \cup (B \cap (C_3 \setminus C_2)) \cup \cdots \cup (B \setminus (B \cap C_m)) \\ &= \left[ B \cap \left( \overline{C_m} \cup \bigcup_{j=0}^{n-1} (C_{2j+1} \setminus C_{2j}) \right) \right] \cup \left[ \overline{B} \cap \left( C_0 \cup \bigcup_{j=1}^{n-1} (C_{2j} \setminus C_{2j-1}) \right) \right] \\ &= \left[ B \cap \left( \overline{C_m} \cup \bigtriangleup_{j=0}^{m-1} C_j \right) \right] \cup \left( \overline{B} \cap \bigtriangleup_{j=0}^m C_j \right) \\ &= \left[ B \cap \left( \overline{\bigtriangleup_{j=1}^m C_j} \right) \right] \cup \left[ \overline{B} \cap \left( \bigtriangleup_{j=1}^m C_j \right) \right] = B \Delta \left( \bigtriangleup_{j=1}^m C_j \right) = A. \end{aligned}$$

- *Case  $m = 2n + 1$ .* Define a mapping  $S : \{l_0, \dots, l_m, r_0, \dots, r_m\} \rightarrow \mathcal{K}$  as follows:

$$\begin{aligned} S(l_m) &= \overline{B}, & S(r_m) &= B, \\ S(l_j) &= \overline{B} \cap C_{j+1} \text{ for } j < m, & S(r_j) &= B \cap C_{j+1} \text{ for } j < m. \end{aligned}$$

A calculation similar to the one above gives  $(\mathfrak{D}_m, S)_1 = A$ . □

For a  $k$ -poset  $(G, f)$  and  $i \in \{1, 2, \dots, k\}$  let  $\mu_i(G, f)$  denote the maximum number of alternations between  $f$ -labels  $i$  and  $f$ -labels different to  $i$  in a chain of  $G$  whose minimum has the label  $i$ , and let  $\mu_{\bar{i}}(G, f)$  denote the maximum number of alternations between  $f$ -labels  $i$  and  $f$ -labels different to  $i$  in a chain of  $G$  whose minimum has a label different to  $i$ .

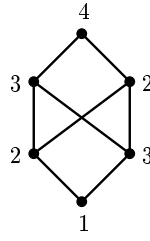

**Fig. 4.3.** The 4-poset generating  $(\mathcal{K}, \mathcal{K}(2), \mathcal{K}(2), \text{co}\mathcal{K})$

**Theorem 4.23. (Projection Theorem.)** *Let  $(G, f)$  be a  $k$ -poset with  $\|f(G)\| \geq 2$  and let  $i \in \{1, 2, \dots, k\}$ . Then the following holds:*

$$\mathcal{K}(G, f)_i = \begin{cases} \mathcal{K}(\mu_i(G, f)) & \text{if } \mu_i(G, f) > \mu_{\bar{i}}(G, f) \text{ and } \mu_i(G, f) \text{ is odd,} \\ \text{co}\mathcal{K}(\mu_i(G, f)) & \text{if } \mu_i(G, f) > \mu_{\bar{i}}(G, f) \text{ and } \mu_i(G, f) \text{ is even,} \\ \mathcal{K}(\mu_{\bar{i}}(G, f)) & \text{if } \mu_{\bar{i}}(G, f) > \mu_i(G, f) \text{ and } \mu_{\bar{i}}(G, f) \text{ is even,} \\ \text{co}\mathcal{K}(\mu_{\bar{i}}(G, f)) & \text{if } \mu_{\bar{i}}(G, f) > \mu_i(G, f) \text{ and } \mu_{\bar{i}}(G, f) \text{ is odd,} \\ (\mathcal{K} \cap \text{co}\mathcal{K}) \oplus \mathcal{K}(\mu_i(G, f)) & \text{if } \mu_i(G, f) = \mu_{\bar{i}}(G, f). \end{cases}$$

*Proof.* Define a mapping  $h_i : \{1, 2, \dots, k\} \rightarrow \{1, 2\}$  for all  $j \in \{1, 2, \dots, k\}$  as

$$h_i(j) =_{\text{def}} \begin{cases} 1 & \text{if } i = j, \\ 2 & \text{if } i \neq j. \end{cases}$$

Obviously,  $\mathcal{K}(G, f)_i = \mathcal{K}(G, h_i \circ f)$ . If  $\mu_i(G, f) \neq \mu_{\bar{i}}(G, f)$  then the minimal 2-poset that is equivalent to the 2-poset  $(G, h_i \circ f)$  is a 2-chain. So in this case the first four cases of theorem can be obtained from Theorem 3.24 by analyzing the chains. So assume that we are in case  $\mu_i(G, f) = \mu_{\bar{i}}(G, f)$ . Let  $m = \mu_i(G, f)$ . Then the minimal 2-poset which is equivalent to  $(G, h_i \circ f)$  is the 2-poset  $\mathcal{D}_m$ . Thus Lemma 4.22 completes the proof.  $\square$

As an example consider the 4-poset  $(G, f)$  represented as described in Figure 4.3. Then we easily calculate:

- $\mu_1(G, f) = 1$  and  $\mu_{\bar{1}}(G, f) = 0$ . Thus,  $\mathcal{K}(G, f)_1 = \mathcal{K}(1) = \mathcal{K}$ .
- $\mu_2(G, f) = 1$  and  $\mu_{\bar{2}}(G, f) = 2$ . Thus,  $\mathcal{K}(G, f)_2 = \mathcal{K}(2)$ .
- $\mu_3(G, f) = 1$  and  $\mu_{\bar{3}}(G, f) = 2$ . Thus,  $\mathcal{K}(G, f)_3 = \mathcal{K}(2)$ .
- $\mu_4(G, f) = 0$  and  $\mu_{\bar{4}}(G, f) = 1$ . Thus,  $\mathcal{K}(G, f)_4 = \text{co}\mathcal{K}(1) = \text{co}\mathcal{K}$ .

Hence,  $\mathcal{K}(G, f) \subseteq (\mathcal{K}, \mathcal{K}(2), \mathcal{K}(2), \text{co}\mathcal{K})$ . Thus the upper bound is already shown. It remains to show that in fact both classes are equal. This will be done in next subsections. Notice that for  $\mathcal{K} = \text{NP}$  the class  $\mathcal{K}(G, f)$  is exactly the projectively closed class for whose projection classes the components of **ENTAILMENT** are complete.

### 4.3.2 Partition Classes Given in Free Representations

We turn to the problem of how to determine which  $k$ -posets describe freely represented classes  $\mathcal{C} = (\mathcal{C}_1, \dots, \mathcal{C}_{k-1}, \cdot)$  with  $\mathcal{C}_i \in \text{BH}_2(\mathcal{K})$  for  $i \in \{1, \dots, k-1\}$ . Note that then the projection

class  $\mathcal{C}_k$  is contained in (but not necessarily equal to) classes from  $\text{BH}_2(\mathcal{K})$  due to Proposition 2.3 and Theorem 2.1. Without loss of generality we suppose that none of the  $\mathcal{C}_i$  with  $i \leq k-1$  is  $\text{co}\mathcal{K}(0)$ . This is justified since  $\text{co}\mathcal{K}(0) = \{\Sigma^*\}$ , thus  $\mathcal{C}_i = \{\Sigma^*\}$  implies  $\mathcal{C}_j = \{\emptyset\}$  for all  $j \neq i$ , and so  $\mathcal{C}$  can be considered a freely represented class with the dot in component  $i$ . Permuting the components yields a partition class as assumed. Admitting trivial components at all becomes extremely useful when considering classes given in bound representation.

For labeled posets we choose a representation as sets of vectors over natural numbers. We consider an  $n$ -tuple  $r = (r_1, \dots, r_n)$  of integers that later on will be used to describe partition classes. For  $r$  let  $m = (m_1, \dots, m_n) \in \mathbb{N}^n$  be an adjoint  $n$ -tuple given by

$$m_i = \begin{cases} \frac{r_i}{2} & \text{if } r_i \geq 0 \text{ and } r_i \text{ is even,} \\ \frac{|r_i|-1}{2} & \text{if } r_i \text{ is odd,} \\ \frac{-r_i-2}{2} & \text{if } r_i < 0 \text{ and } r_i \text{ is even.} \end{cases} \quad (4.5)$$

Define an  $(n+1)$ -poset  $\mathfrak{B}_r = (B_r, f)$  depending on the tuple  $r$  as follows:

$$\begin{aligned} B_r =_{\text{def}} & \{ x \in \mathbb{N}^n \mid x_\nu \in \{1, 2, \dots, 2m_\nu + 1\} \text{ for all } \nu, \text{ and } \|\{\nu \mid x_\nu \text{ is even}\}\| \leq 1 \} \\ & \cup \{ x \in \mathbb{N}^n \mid r_\nu \geq 0, r_\nu \text{ is odd, } x_\nu = 0, \text{ and } x_\mu = 1 \text{ for } \nu \neq \mu \} \\ & \cup \{ x \in \mathbb{N}^n \mid r_\nu < 0, r_\nu \text{ is even, } x_\nu = 0, \text{ and } x_\mu = 1 \text{ for } \nu \neq \mu \} \\ & \cup \{ x \in \mathbb{N}^n \mid r_\nu < 0, x_\nu = 2m_\nu + 2, \text{ and } x_\mu = 2m_\mu + 1 \text{ for } \nu \neq \mu \} \end{aligned}$$

Consider  $B_r$  to be partially ordered by the vector-ordering. For each  $x \in B_r$  let

$$f(x) =_{\text{def}} \begin{cases} \nu & \text{if } x_\nu \text{ is even and } x_\mu \text{ is odd for } \nu \neq \mu, \\ n+1 & \text{if } x_\mu \text{ is odd for all } \mu. \end{cases}$$

Although the representation seems technically involved  $\mathfrak{B}_r$  is easy to handle for several cases. For instance, if  $n = 1$  then  $\mathfrak{B}_{2s}$  is simply a 2-chain with  $2s + 1$  elements alternately labeled with 1 and 2 and the least element has label 2. For  $n = 2$  the 3-poset  $\mathfrak{B}_{2s, 2t}$  can be drawn as the grid in Figure 4.4. For  $n = 3$  the 4-posets  $\mathfrak{B}_{2s, 2t, 2u}$  are depicted by 3-dimensional cuboids as done for  $\mathfrak{B}_{2, 2, 2}$  in Figure 4.5.

The next proposition compares labeled posets with respect to tuples.

**Proposition 4.24.** *Let  $r$  and  $r'$  be any  $n$ -tuples of integers such that  $|r_i| \leq |r'_i|$  for all  $1 \leq i \leq n$ . Then  $\mathfrak{B}_r \leq \mathfrak{B}_{r'}$ .*

*Proof.* In this case we have  $B_r \subseteq B_{r'}$ . □

The following lemma shows the connection between a labeled poset  $\mathfrak{B}_r$  and its complexity in terms of label-alternations.

**Lemma 4.25.** *Let  $r = (r_1, \dots, r_n)$  be any  $n$ -tuple over integers and let  $j \in \{1, \dots, n\}$ .*

1. If  $r_j = 0$  then  $\mu_j(\mathfrak{B}_r) = \mu_{\bar{j}}(\mathfrak{B}_r) = 0$ .
2. If  $r_j > 0$  and  $r_j$  is even then  $\mu_j(\mathfrak{B}_r) < \mu_{\bar{j}}(\mathfrak{B}_r) = r_j$ .
3. If  $r_j > 0$  and  $r_j$  is odd then  $\mu_{\bar{j}}(\mathfrak{B}_r) < \mu_j(\mathfrak{B}_r) = r_j$ .
4. If  $r_j < 0$  and  $r_j$  is even then  $\mu_{\bar{j}}(\mathfrak{B}_r) < \mu_j(\mathfrak{B}_r) = -r_j$ .
5. If  $r_j < 0$  and  $r_j$  is odd then  $\mu_j(\mathfrak{B}_r) < \mu_{\bar{j}}(\mathfrak{B}_r) = -r_j$ .

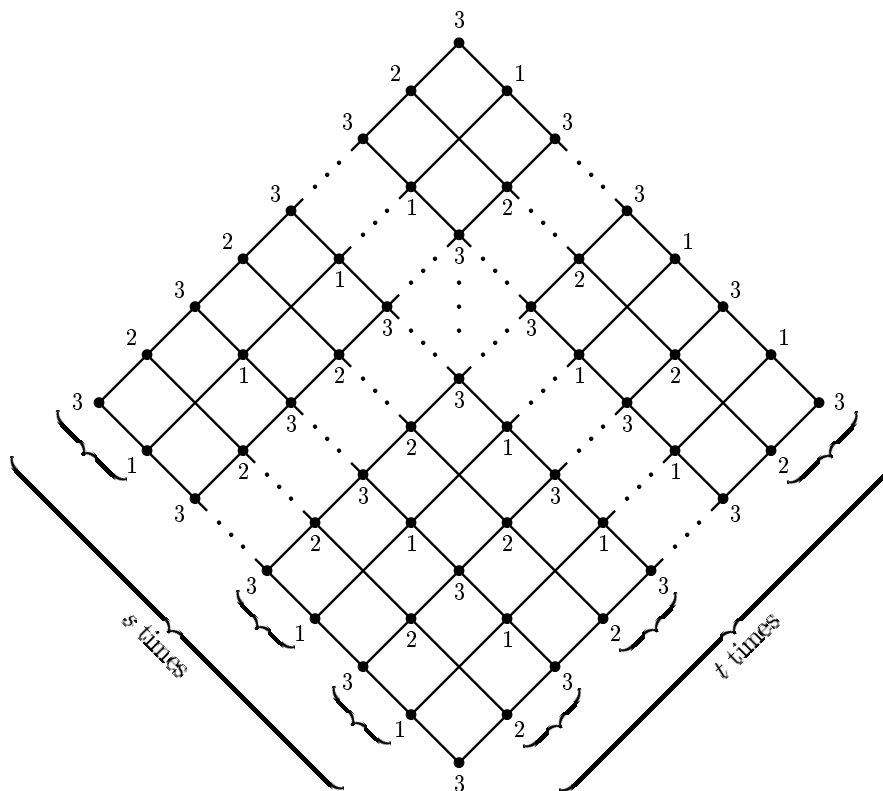

Fig. 4.4. The 3-poset  $\mathfrak{B}_{2s,2t}$  for  $s, t \in \mathbb{N}$

*Proof.* The first statement is obvious. From the other statements we only prove the second one. In this case the set  $B_r$  coincides with the first set in the definition. The remaining statements can be easily concluded by observing which tuples are added as new least and greatest elements via the other sets. We consider  $r$  with  $r_j > 0$  and  $r_j$  is even. Clearly the least tuple in  $B_r$  is  $(1, \dots, 1)$  and thus labeled with  $n + 1$ . Moreover the greatest tuple in  $B_r$  is  $(2m_1 + 1, \dots, 2m_n + 1)$  and thus labeled with  $n + 1$  where  $(m_1, \dots, m_n)$  is the adjoint tuple according to Equation (4.5). From both facts it is seen that  $\mu_{\bar{j}}(\mathfrak{B}_r) > \mu_j(\mathfrak{B}_r)$ . The proof of  $\mu_{\bar{j}}(\mathfrak{B}_r) = r_j = 2m_j$  is by induction on  $m_j$ . Let the induction start at  $m_j = 0$  for which the statement obviously holds. Now assume the statement is already shown for  $m_j$ . Consider  $m_j + 1$ . Then the following holds:

$$\begin{aligned}
 & B_{(r_1, \dots, r_j+2, \dots, r_n)} \\
 &= B_{(r_1, \dots, r_j, \dots, r_n)} \\
 &\quad \cup \{ (x_1, \dots, 2m_j + 2, \dots, x_n) \mid 1 \leq x_\nu \leq 2m_\nu + 1 \text{ and } x_\nu \text{ is odd for all } \nu \neq j \} \\
 &\quad \cup \{ (x_1, \dots, 2m_j + 3, \dots, x_n) \mid 1 \leq x_\nu \leq 2m_\nu + 1 \text{ for all } \nu \neq j \text{ and} \\
 &\hspace{15em} \text{at most one } x_\nu \text{ is even} \}.
 \end{aligned}$$

By assumption of the induction each longest alternating chain in  $\mathfrak{B}_r$  has exactly  $2m_j$  alternations of  $j$ -labels and  $l$ -labels with  $l \neq j$  (starting with a  $j$ -label). Consider a longest alternating chain that starts in  $(1, \dots, 1)$  and that ends in  $(2m_1 + 1, \dots, 2m_j + 1, \dots, 2m_n + 1)$ . Such a

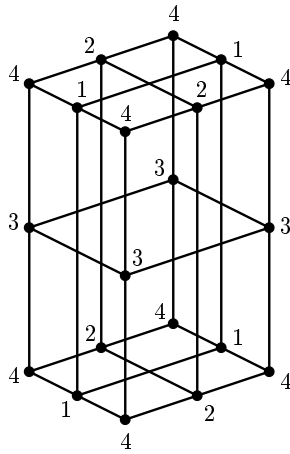

Fig. 4.5. The 4-poset  $\mathfrak{B}_{2,2,2}$

chain always exists. Now by switching in the  $j$ -th component from  $2m_j + 1$  to  $2m_j + 2$  to  $2m_j + 3$  we easily obtain

$$\mu_{\bar{j}}(\mathfrak{B}_{(r_1, \dots, r_j+2, \dots, r_n)}) = 2(m_j + 1).$$

□

The lemma is useful, e.g., in proving the following Embedding Theorem for a subclass of labeled posets.

**Theorem 4.26.** *Assume the boolean hierarchy of sets over  $\mathcal{K}$  is infinite. Let  $r$  and  $r'$  any  $n$ -tuples of integers. Then  $\mathcal{K}(\mathfrak{B}_r) \subseteq \mathcal{K}(\mathfrak{B}_{r'})$  if and only if  $\mathfrak{B}_r \leq \mathfrak{B}_{r'}$ .*

*Proof.* The direction “ $\Leftarrow$ ” follows from the Embedding Lemma. For “ $\Rightarrow$ ” suppose  $\mathfrak{B}_r \not\leq \mathfrak{B}_{r'}$ . Assume that  $\mathcal{K}(\mathfrak{B}_r) \subseteq \mathcal{K}(\mathfrak{B}_{r'})$ . By Proposition 4.24 there is an  $i$  such that  $|r_i| > |r'_i|$ . By Lemma 4.25 and the Projection Theorem we conclude that one of the classes  $\mathcal{K}(|r_i|)$  and  $\text{co}\mathcal{K}(|r_i|)$  coincides with  $\mathcal{K}(|r'_i|)$  or  $\text{co}\mathcal{K}(|r'_i|)$  which implies that the boolean hierarchy collapses to level  $|r'_i|$ , a contradiction. □

Connections between posets  $\mathfrak{B}_r$  and partition classes are given by boolean characteristics. Let  $\mathcal{C}$  be a class of  $k$ -partitions that can be freely represented by  $k - 1$  classes from the boolean hierarchy of sets over  $\mathcal{K}$ . A  $(k - 1)$ -tuple  $\beta$  of integers is said to be a *boolean characteristic of  $\mathcal{C}$  with respect to  $\mathcal{K}$*  if for all  $i \in \{1, \dots, k - 1\}$ ,

$$\mathcal{C}_i = \begin{cases} \mathcal{K}(\beta_i) & \text{if } \beta_i \geq 0, \\ \text{co}\mathcal{K}(-\beta_i) & \text{if } \beta_i < 0. \end{cases}$$

Note that depending on the class  $\mathcal{K}$ , a freely represented partition class can only have exactly one boolean characteristic (e.g., if the boolean hierarchy of sets over  $\mathcal{K}$  is infinite) or infinitely many boolean characteristics.

**Theorem 4.27.** *Let  $\mathcal{C}$  be any class of  $k$ -partitions that can be freely represented by  $k - 1$  classes from the boolean hierarchy of sets over  $\mathcal{K}$ . Let  $\beta$  be any boolean characteristic of  $\mathcal{C}$  with respect to  $\mathcal{K}$ . Then  $\mathcal{C} = \mathcal{K}(\mathfrak{B}_\beta)$ .*



*Proof.* We first prove the theorem only for classes  $\mathcal{C}$  having a boolean characteristic  $\beta$  with  $\beta_i < 0$  and  $\beta_i$  is even for all  $i$ . Let  $m_i \in \mathbb{N}$  satisfy  $\beta_i = -2m_i - 2$ . That means  $\mathcal{C}_i = \text{co}\mathcal{K}(2m_i + 2)$  for all  $i$ . Consider the  $k$ -poset  $\mathfrak{B}_\beta = (B_\beta, f)$ . Note that the tuple  $m = (m_1, \dots, m_{k-1})$  is precisely the tuple adjoint to  $\beta$  in the sense of Equation (4.5). We have to show that  $\mathcal{C} = \mathcal{K}(\mathfrak{B}_\beta)$ . The inclusion “ $\supseteq$ ” follows directly from Lemma 4.25 and the Projection Theorem 4.23. For “ $\subseteq$ ” let  $A$  be a partition in  $(\text{co}\mathcal{K}(2m_1 + 2), \dots, \text{co}\mathcal{K}(2m_{k-1} + 2), \cdot)$ . For all  $j \in \{1, 2, \dots, k-1\}$  there exist sets  $C_i^j \in \mathcal{K}$  with  $C_0^j \subseteq \dots \subseteq C_{2m_j+1}^j$  such that

$$A_j = C_0^j \cup \left( \bigcup_{l=1}^{m_j} (C_{2l}^j \setminus C_{2l-1}^j) \right) \cup \overline{C_{2m_j+1}^j}.$$

Moreover we easily observe that

1.  $C_0^j \subseteq C_{2m_r+1}^l$  for all  $j, l$ ,
2.  $C_{2m_j+1}^j \cup C_{2m_i+1}^l = M$  for all  $j, l$  with  $j \neq l$ ,
3.  $C_{2l}^j \setminus C_{2l-1}^j \subseteq C_{2m_i+1}^i$  for all  $i, j, l$ .

For convenience we set  $C_{-1}^j = \emptyset$  and  $C_{2m_j+2}^j = M$ . Define a mapping  $S : B_\beta \rightarrow \mathcal{K}$  as

$$S(i_1, \dots, i_{k-1}) =_{\text{def}} \begin{cases} C_0^j & \text{if } i_j = 0 \text{ and } i_\nu = 1 \text{ for all } \nu \neq j, \\ \left( \bigcup_{j=1}^{k-1} C_0^j \right) \cup \left( \bigcap_{j=1}^{k-1} C_{i_j}^j \right) & \text{otherwise.} \end{cases}$$

Note that  $S$  is monotonic. We first have to show that  $S$  is a  $\mathcal{K}$ -homomorphism on  $B_\beta$ , i.e., that the following is true:

1.  $\bigcup_{a \in B_\beta} S(a) = M$ ,
2.  $S(a) \cap S(b) = \bigcup_{c \leq a, c \leq b} S(c)$ .

This is shown as follows:

1. We conclude

$$\begin{aligned} \bigcup_{a \in B_\beta} S(a) &= \left( \bigcup_{j=1}^{k-1} C_0^j \right) \cup \bigcup_{j=1}^{k-1} \bigcap_{l=1, l \neq j}^{k-1} C_{2m_l+1}^l = \bigcup_{j=1}^{k-1} \bigcap_{l=1, l \neq j}^{k-1} C_{2m_l+1}^l \\ &= \bigcup_{j=1}^{k-1} \left( C_{2m_j+1}^j \cap \bigcup_{l=1, l \neq j}^{k-1} C_{2m_l+1}^l \right) = \bigcup_{j=1}^{k-1} C_{2m_j+1}^j = M. \end{aligned}$$

2. It is enough to consider three cases for  $a, b \in B_\beta$  with  $a \neq b$ .

- *Case*  $a, b > (2m_1 + 1, \dots, 2m_{k-1} + 1)$ . That means  $a, b$  are maximal elements in  $B_\beta$ . Let  $a = (2m_1 + 1, \dots, 2m_j + 2, \dots, 2m_{k-1} + 1)$  and let  $b = (2m_1 + 1, \dots, 2m_l + 1, \dots, 2m_{k-1} + 1)$  with  $j \neq l$ . Then we have

$$\begin{aligned}
S(a) \cap S(b) &= \left( \bigcap_{i=1, i \neq j}^{k-1} C_{2m_i+1}^i \right) \cap \left( \bigcap_{i=1, i \neq l}^{k-1} C_{2m_i+1}^i \right) = \bigcap_{i=1}^{k-1} C_{2m_i+1}^i \\
&= S(2m_1 + 1, \dots, 2m_{k-1} + 1).
\end{aligned}$$

The latter is just the value of  $S$  at the maximal vector less than both  $a$  and  $b$ . So the assertion follows from the monotonicity of  $S$ .

- *Case  $a, b < (1, \dots, 1)$ .* That is  $a, b$  are minimal elements in  $B_\beta$ . Let  $a$  and  $b$  be tuples of the form  $(1, \dots, 1, 0, 1, \dots, 1)$  where in  $a$  the zero occurs at position  $j$  and in  $b$  the zero occurs at position  $l$  with  $j \neq l$ . Note that there exist no tuple in  $B_\beta$  less than both  $a$  and  $b$ . So  $S(a)$  and  $S(b)$  must be disjoint. Indeed, we conclude

$$S(a) \cap S(b) = C_0^j \cap C_0^l = \emptyset.$$

- *Case  $(1, \dots, 1) \leq a, b \leq (2m_1 + 1, \dots, 2m_{k-1} + 1)$ .* Let  $a = (i_1, \dots, i_{k-1})$  and let  $b = (j_1, \dots, j_{k-1})$ . Then it holds

$$\begin{aligned}
S(a) \cap S(b) &= \left[ \left( \bigcup_{l=1}^{k-1} C_0^l \right) \cup \bigcap_{l=1}^{k-1} C_{i_l}^l \right] \cap \left[ \left( \bigcup_{l=1}^{k-1} C_0^l \right) \cup \bigcap_{l=1}^{k-1} C_{j_l}^l \right] \\
&= \left( \bigcup_{l=1}^{k-1} C_0^l \right) \cup \bigcap_{l=1}^{k-1} C_{\min\{i_l, j_l\}}^l. \tag{4.6}
\end{aligned}$$

There are at most two different indexes  $l_1, l_2$  such that  $\min\{i_{l_\nu}, j_{l_\nu}\}$  is even for  $\nu \in \{1, 2\}$ .

If there exist strictly less than two even minima then the tuple  $c = (\min\{i_1, j_1\}, \dots, \min\{i_{k-1}, j_{k-1}\})$  belongs to  $B_\beta$ . From Equation (4.6) we obtain  $S(a) \cap S(b) = S(c)$ . Since  $c$  is the maximal tuple in  $B_\beta$  which is less than both  $a$  and  $b$  the monotonicity of  $S$  proves the assertion for this subcase.

If there are exactly two even minima then without loss of generality, let  $i_s$  and  $j_t$  be the even minima with  $s < t$ . Note that  $i_s, j_t \geq 2$ . Since the set differences  $C_{i_s}^s \setminus C_{i_s-1}^s$  and  $C_{j_t}^t \setminus C_{j_t-1}^t$  are disjoint we get

$$C_{i_s}^s \cap C_{j_t}^t = C_{i_s}^s \cap C_{j_t}^t \cap (C_{i_s-1}^s \cup C_{j_t-1}^t) = (C_{i_s-1}^s \cap C_{j_t}^t) \cup (C_{i_s}^s \cap C_{j_t-1}^t).$$

Using this equality and Equation (4.6) we easily see that

$$\begin{aligned}
S(a) \cap S(b) &= S(\min\{i_1, j_1\}, \dots, \min\{i_s, j_s\} - 1, \dots, \min\{i_t, j_t\}, \dots, \min\{i_{k-1}, j_{k-1}\}) \\
&\quad \cup S(\min\{i_1, j_1\}, \dots, \min\{i_s, j_s\}, \dots, \min\{i_t, j_t\} - 1, \dots, \min\{i_{k-1}, j_{k-1}\})
\end{aligned}$$

The tuples from the last two lines have exactly one even minimum each and thus belong to  $B_\beta$ . Moreover, they are the only maximal tuples in  $B_\beta$  less than both  $a$  and  $b$ . Once more the monotonicity of  $S$  gives the assertion.

It remains to show that  $(\mathfrak{B}_\beta, S) = A$ . To do that we first prove the following claim.

**Claim.** For all  $s, r_2, \dots, r_{k-1} \in \mathbb{N}$  with  $s \geq 1$  and  $r_j \leq m_j$  for  $j \in \{2, 3, \dots, k-1\}$  it holds

$$\bigcup_{(i_2, \dots, i_{k-1})=(0, \dots, 0)}^{(r_2, \dots, r_{k-1})} T_S(2s, 2i_2 + 1, \dots, 2i_{k-1} + 1) = (C_{2s}^1 \setminus C_{2s-1}^1) \cap \bigcap_{j=2}^{k-1} C_{2r_j+1}^j.$$

*Proof of the claim.* (Induction on  $(r_2, \dots, r_{k-1})$ )

- Let  $(r_2, \dots, r_{k-1}) = (0, \dots, 0)$ . Then we conclude

$$\begin{aligned} & T_S(2s, 1, \dots, 1) \\ &= S(2s, 1, \dots, 1) \setminus S(2s-1, 1, \dots, 1) \\ &= \left[ \left( \bigcup_{j=1}^{k-1} C_0^j \right) \cup \left( C_{2s}^1 \cap \bigcap_{j=2}^{k-1} C_1^j \right) \right] \setminus \left[ \left( \bigcup_{j=1}^{k-1} C_0^j \right) \cup \left( C_{2s-1}^1 \cap \bigcap_{j=2}^{k-1} C_1^j \right) \right] \\ &= \overline{\left( \bigcup_{j=1}^{k-1} C_0^j \right)} \cap (C_{2s}^1 \setminus C_{2s-1}^1) \cap \bigcap_{j=2}^{k-1} C_1^j = (C_{2s}^1 \setminus C_{2s-1}^1) \cap \bigcap_{j=2}^{k-1} C_1^j \end{aligned}$$

This shows the base of induction.

- Assume the claim holds for  $(r_2, \dots, r_t, \dots, r_{k-1})$ . Consider  $(r_2, \dots, r_t + 1, \dots, r_{k-1})$ . We only have something to show if  $r_t + 1 \leq m_t$ . For convenience, we may assume that  $t = 2$ . Set  $C_{-1}^j = \emptyset$ . First we calculate  $T_S(2s, 2r_3 + 3, 2i_3 + 1, \dots, 2i_{k-1} + 1)$  with  $(i_3, \dots, i_{k-1}) \leq (r_3, \dots, r_{k-1})$ .

$$T_S(2s, 2r_3 + 3, 2i_3 + 1, \dots, 2i_{k-1} + 1) = D_1 \cap D_2 \cap D_3 \quad (4.7)$$

where the sets  $D_1$ ,  $D_2$ , and  $D_3$  are given as

$$\begin{aligned} D_1 &= S(2s, 2r_2 + 3, 2i_3 + 1, \dots, 2i_{k-1} + 1) \\ &\quad \setminus S(2s-1, 2r_2 + 3, 2i_3 + 1, 2i_4 + 1, \dots, 2i_{k-1} + 1), \\ D_2 &= S(2s, 2r_2 + 3, 2i_3 + 1, \dots, 2i_{k-1} + 1) \\ &\quad \setminus S(2s, 2r_2 + 1, 2i_3 + 1, 2i_4 + 1, \dots, 2i_{k-1} + 1), \\ D_3 &= S(2s, 2r_2 + 3, 2i_3 + 1, \dots, 2i_{k-1} + 1) \\ &\quad \setminus \left( \begin{aligned} & S(2s, 2r_2 + 3, 2i_3 - 1, 2i_4 + 1, \dots, 2i_{k-1} + 1) \\ & \cup S(2s, 2r_2 + 3, 2i_3 + 1, 2i_4 - 1, \dots, 2i_{k-1} + 1) \\ & \vdots \\ & \cup S(2s, 2r_2 + 3, 2i_3 + 1, 2i_4 + 1, \dots, 2i_{k-1} - 1) \end{aligned} \right). \end{aligned}$$

For these sets we obtain

$$\begin{aligned}
D_1 &= \overline{\left( \bigcup_{j=1}^{k-1} C_0^j \right)} \cap (C_{2s}^1 \setminus C_{2s-1}^1) \cap C_{2r_2+3}^2 \cap \bigcap_{j=3}^{k-1} C_{2i_j+1}^j, \\
D_2 &= \overline{\left( \bigcup_{j=1}^{k-1} C_0^j \right)} \cap C_{2s}^1 \cap (C_{2r_2+3}^2 \setminus C_{2r_2+1}^2) \cap \bigcap_{j=3}^{k-1} C_{2i_j+1}^j, \\
D_3 &= \overline{\left( \bigcup_{j=1}^{k-1} C_0^j \right)} \cap C_{2s}^1 \cap C_{2r_2+3}^2 \cap \bigcap_{j=3}^{k-1} \left[ (C_{2i_j+1}^j \setminus C_{2i_{j-1}}^j) \cap \bigcap_{l=3, l \neq j}^{k-1} C_{2i_l+1}^l \right].
\end{aligned}$$

Putting these identities in Equation (4.7) and simplifying the terms it is seen that

$$\begin{aligned}
&T_S(2s, 2r_3 + 3, 2i_3 + 1, \dots, 2i_{k-1} + 1) \\
&= (C_{2s}^1 \setminus C_{2s-1}^1) \cap (C_{2r_2+3}^2 \setminus C_{2r_2+1}^2) \cap \bigcap_{j=3}^{k-1} (C_{2i_j+1}^j \setminus C_{2i_{j-1}}^j).
\end{aligned}$$

Using this equality and the assumption of induction we finally calculate

$$\begin{aligned}
&\bigcup_{\substack{(r_2+1, r_3, \dots, r_{k-1}) \\ (i_2, i_3, \dots, i_{k-1}) = (0, 0, \dots, 0)}} T_S(2s, 2i_2 + 1, \dots, 2i_{k-1} + 1) \\
&= \left( \bigcup_{\substack{(r_3, \dots, r_{k-1}) \\ (i_3, \dots, i_{k-1}) = (0, \dots, 0)}} T_S(2s, 2r_2 + 3, 2i_3 + 1, \dots, 2i_{k-1} + 1) \right) \\
&\quad \cup \left( \bigcup_{\substack{(r_2, r_3, \dots, r_{k-1}) \\ (i_2, i_3, \dots, i_{k-1}) = (0, 0, \dots, 0)}} T_S(2s, 2i_2 + 1, 2i_3 + 1, \dots, 2i_{k-1} + 1) \right) \\
&= \left( (C_{2s}^1 \setminus C_{2s-1}^1) \cap (C_{2r_2+3}^2 \setminus C_{2r_2+1}^2) \cap \bigcup_{\substack{(r_3, \dots, r_{k-1}) \\ (i_3, \dots, i_{k-1}) = (0, \dots, 0)}} \bigcap_{j=3}^{k-1} (C_{2i_j+1}^j \setminus C_{2i_{j-1}}^j) \right) \\
&\quad \cup \left( (C_{2s}^1 \setminus C_{2s-1}^1) \cap \bigcap_{j=2}^{k-1} C_{2r_j+1}^j \right) \\
&= \left( (C_{2s}^1 \setminus C_{2s-1}^1) \cap (C_{2r_2+3}^2 \setminus C_{2r_2+1}^2) \cap \bigcap_{j=3}^{k-1} C_{2r_j+1}^j \right) \\
&\quad \cup \left( (C_{2s}^1 \setminus C_{2s-1}^1) \cap C_{2r_2+1}^2 \cap \bigcap_{j=3}^{k-1} C_{2r_j+1}^j \right) \\
&= (C_{2s}^1 \setminus C_{2s-1}^1) \cap C_{2r_2+3}^2 \cap \bigcap_{j=3}^{k-1} C_{2r_j+1}^j.
\end{aligned}$$

Hence, the claim is proven.

As an immediate consequence of the claim we get that for  $s \in \mathbb{N}_+$  the following is true:

$$\bigcup_{(i_2, \dots, i_{k-1})=(0, \dots, 0)}^{(m_2, \dots, m_{k-1})} T_S(2s, 2i_2 + 1, \dots, 2i_{k-1} + 1) = C_{2s}^1 \setminus C_{2s-1}^1. \quad (4.8)$$

In fact, Equation (4.8) has been the intention why we have proven the claim at all.

Now we determine the first component of the partition  $(\mathfrak{B}_\beta, S)$ . Consider the set of all tuples  $(j_1, j_2, \dots, j_{k-1}) \in B_\beta$  satisfying that  $j_1 > 0$  is even and  $j_2, \dots, j_{k-1}$  are odd, i.e., all tuples  $(j_1, j_2, \dots, j_{k-1})$  such that there exist  $i_1 \in \mathbb{N}_+$ ,  $i_2, \dots, i_{k-1} \in \mathbb{N}$  with  $i_l \leq m_l$  for all  $l \in \{1, 2, \dots, k-1\}$ ,  $j_1 = 2i_1$ , and  $j_l = 2i_l + 1$  for all  $l \in \{2, 3, \dots, k-1\}$ . With Equation (4.8) in mind we then conclude

$$\begin{aligned} & (\mathfrak{B}_\beta, S)_1 \\ &= S(0, 1, \dots, 1) \cup \left( \bigcup_{i=1}^{m_1} \bigcup_{(j_2, \dots, j_{k-1})=(0, \dots, 0)}^{(m_2, \dots, m_{k-1})} T_S(2i, 2j_2 + 1, \dots, 2j_{k-1} + 1) \right) \\ & \quad \cup (S(2m_1 + 3, 2m_2 + 1, \dots, 2m_{k-1} + 1) \setminus S(2m_1 + 1, 2m_2 + 1, \dots, 2m_{k-1} + 1)) \\ &= C_0^j \cup \left( \bigcup_{i=1}^{m_1} (C_{2i}^1 \setminus C_{2i-1}^1) \right) \cup \left[ \left( \bigcap_{i=2}^{k-1} C_{2m_i-1}^i \right) \setminus \bigcap_{i=1}^{k-1} C_{2m_i+1}^i \right] \\ &= C_0^j \cup \left( \bigcup_{i=1}^{m_1} (C_{2i}^1 \setminus C_{2i-1}^1) \right) \cup \left( \overline{C_{2m_1+1}^1} \cap \bigcap_{i=2}^{k-1} C_{2m_i+1}^i \right) \\ &= C_0^j \cup \left( \bigcup_{i=1}^{m_1} (C_{2i}^1 \setminus C_{2i-1}^1) \right) \cup \overline{C_{2m_1+1}^1} = A_1. \end{aligned}$$

Completely similar to this (also including the claim) one can show the equality for all other components  $j \in \{2, 3, \dots, k-1\}$ . Hence,  $(\mathfrak{B}_\beta, S) = A$ . Consequently,  $A \in \mathcal{K}(\mathfrak{B}_\beta)$ .

Thus, the first step of the proof of our theorem is completely proven, i.e., the statement of the theorem is true for partition classes  $\mathcal{C}$  and boolean characteristics  $\beta$  with  $\beta_i < 0$  and  $\beta$  is even. Validity of the theorem for other partition classes result from slight modifications. For instance, if  $\beta_i > 0$  and  $\beta_i$  is even then by Lemma 4.25 and the Projection Theorem  $\mathcal{K}(\mathfrak{B}_\beta)_i \subseteq \mathcal{K}(\beta_i)$ . Conversely, it is enough to observe that for  $A$  with  $A_i \in \mathcal{K}(2m_i)$  with  $\beta_i = 2m_i$  we can simply set  $C_0^i = \emptyset$  and  $C_{2m_i+2}^i = M$  in the proof of “ $\supseteq$ ” above. All other cases can be shown analogously.  $\square$

As a consequence of this theorem we conclude:

**Corollary 4.28.**  $\mathcal{K}(\mathfrak{B}_r)$  is projectively closed for all  $n$ -tuples  $r$  of integers.

Moreover, Theorem 4.27 give us a method to figure out labeled posets for each projectively closed class. As an example, the partition class  $(\text{co}\mathcal{K}(4), \text{co}\mathcal{K}(5), \cdot)$  can be described by the 3-poset pictured in Figure 4.6.

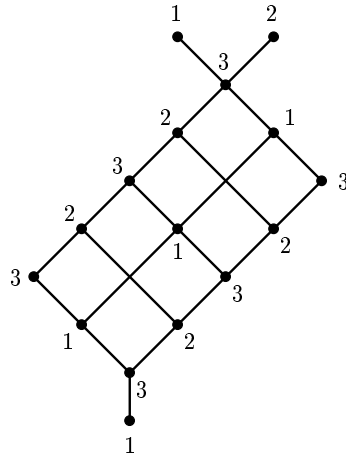

Fig. 4.6. The 3-poset generating  $(\text{co}\mathcal{K}(4), \text{co}\mathcal{K}(5), \cdot)$

### 4.3.3 Partition Classes Given in Bound Representations

In the previous subsection we have completely solved the problem of characterizing the freely represented  $k$ -partition classes that are explicitly given by  $k - 1$  components of the boolean hierarchy of sets over  $\mathcal{K}$ . Now we are going to solve the same problem for boundly represented partition classes. The key for this is already given by Theorem 4.27 because we clearly have the following bridge between freely and boundly represented partition classes.

**Proposition 4.29.** *Let  $(\mathcal{C}_1, \dots, \mathcal{C}_{k-1}, \cdot)$  be any partition class and let  $(G, f)$  be any  $k$ -poset such that  $\mathcal{K}(G, f) = (\mathcal{C}_1, \dots, \mathcal{C}_{k-1}, \cdot)$ . Then it holds that  $(\mathcal{C}_1, \dots, \mathcal{C}_{k-1}, \{\emptyset\}) = \mathcal{K}(G', f')$  with  $G' = G \setminus \{a \in G \mid f(a) = k\}$ .*

From this proposition we easily conclude:

**Theorem 4.30.** *Let  $\mathcal{C} = (\mathcal{C}_1, \dots, \mathcal{C}_k)$  be any class of  $k$ -partitions that can be boundly represented by classes from the boolean hierarchy of sets over  $\mathcal{K}$ . Let  $\beta$  be any boolean characteristic of the corresponding freely represented class  $(\mathcal{C}_1, \dots, \mathcal{C}_k, \cdot)$  with respect to  $\mathcal{K}$ . Then  $\mathcal{C} = \mathcal{K}(\mathfrak{B}'_\beta)$  where  $\mathfrak{B}'_\beta$  is the  $k$ -poset that emerges from the  $(k + 1)$ -poset  $\mathfrak{B}_\beta$  by eliminating all elements having label  $k + 1$ .*

*Proof.* Follows from Theorem 4.27 and Proposition 4.29 via

$$(A_1, \dots, A_k) \in (\mathcal{C}_1, \dots, \mathcal{C}_k) \iff (A_1, \dots, A_k, \emptyset) \in (\mathcal{C}_1, \dots, \mathcal{C}_k, \cdot)$$

□

Applying this theorem leads directly to the 4-poset in Figure 4.3 as a representation of the class  $(\mathcal{K}, \mathcal{K}(2), \mathcal{K}(2), \text{co}\mathcal{K})$ .

We should note that the  $k$ -posets we obtain from Theorem 4.30 are, in general, not minimal  $k$ -posets opposite to those constructed in Theorem 4.27. So after calculating the  $k$ -poset for a given boundly represented classes of  $k$ -partitions we have to minimize the labeled poset. Remind that there exists a up to isomorphy unique minimal equivalent  $k$ -poset. As an example, the  $k$ -poset in Figure 4.7 is the minimal  $k$ -poset which is equivalent to

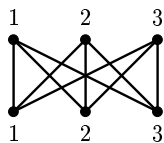

**Fig. 4.7.** The 3-poset generating  $(\mathcal{K}(2), \mathcal{K}(2), \mathcal{K}(2))$

the  $k$ -poset we obtain from the theorem above to represent  $(\mathcal{K}(2), \mathcal{K}(2), \mathcal{K}(2))$ . Note that  $(\mathcal{K}(2), \mathcal{K}(2), \mathcal{K}(2), \cdot) = \mathcal{K}(\mathfrak{B}_{2,2,2})$  (see Figure 4.5).

Theorem 4.30 has an interesting consequence for the boolean hierarchy of sets. We can describe each class  $\mathcal{K}(m) \cap \text{co}\mathcal{K}(m)$  as a class generated by labeled posets. For  $m \in \mathbb{N}_+$  let  $\mathfrak{H}_m$  be the 2-poset presented in Figure 4.8.

**Corollary 4.31.**  $\mathcal{K}(m) \cap \text{co}\mathcal{K}(m) = \mathcal{K}(\mathfrak{H}_m)$  for all  $m \in \mathbb{N}_+$ .

*Proof.* Note that  $\mathcal{K}(m) \cap \text{co}\mathcal{K}(m) = (\mathcal{K}(m), \mathcal{K}(m))_1$ . According to Theorem 4.30 we first have to calculate the 3-poset that describes  $(\mathcal{K}(m), \mathcal{K}(m), \cdot)$ . This is the  $k$ -poset  $\hat{\mathfrak{G}}_{m,m}$  from Theorem 4.27. Then we eliminate all elements labeled with 3. This yields the set

$$G = \begin{cases} \{ (i, j) \mid i, j \in \{0, 1, \dots, 2m+1\} \text{ and either } i \text{ or } j \text{ is odd} \} & \text{if } m \text{ is odd,} \\ \{ (i, j) \mid i, j \in \{1, \dots, 2m+1\} \text{ and either } i \text{ or } j \text{ is odd} \} & \text{if } m \text{ is even.} \end{cases}$$

Thus  $(G, f_m)$  generates  $(\mathcal{K}(m), \mathcal{K}(m))$ . Now consider the set  $G'$  defined as

$$G' =_{\text{def}} \begin{cases} \{ (i, j) \mid i, j \in \{0, 1, \dots, 2m+1\} \wedge (i = j+1 \vee j = i+1) \} & \text{if } m \text{ is odd,} \\ \{ (i, j) \mid i, j \in \{1, \dots, 2m+1\} \wedge (i = j+1 \vee j = i+1) \} & \text{if } m \text{ is even.} \end{cases}$$

Note that  $G'$  consists only of pairs  $(i, j)$  with  $i \neq j$ . It holds that  $(G, f_m) \equiv (G', f_m)$  as can be seen as follows:  $(G', f_m) \leq (G, f_m)$  is witnessed by the identity function and  $(G, f_m) \leq (G', f_m)$  is witnessed by the following monotonic function  $\varphi : G \rightarrow G'$

$$\varphi(i, j) =_{\text{def}} \begin{cases} (i, i-1) & \text{if } i > j, \\ (j-1, j) & \text{if } i < j. \end{cases}$$

But  $(G', f_m)$  is isomorphic to  $\mathfrak{H}_m$ . By the Embedding Lemma,  $(\mathcal{K}(m), \mathcal{K}(m)) = \mathcal{K}(\mathfrak{H}_m)$ .  $\square$

## 4.4 A Relativized Embedding Theorem

In Section 4.1 we have defined partition classes over posets. In Section 4.2 it has been given an alternative characterization of these classes in terms of lattices with associated proper subsets. For both structures we have identified relations inducing a sufficient criterion for inclusions between partition classes. The natural question to ask is, as we did for lattices: Are the relations in the NP case also necessary for inclusion? In this section we give some reasons of why we are convinced of the sufficient criterion to be also necessary. The main result is Theorem 4.42 stating that we have a relativizable inclusion between partition classes from refined boolean hierarchy over NP if and only if the defining  $k$ -posets are in relation  $\leq$ .

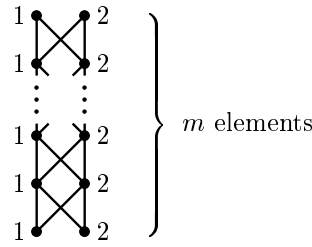

Fig. 4.8. The 2-poset  $\mathfrak{H}_m$  for  $m \in \mathbb{N}_+$

### 4.4.1 Refined Boolean Hierarchies and the Polynomial Hierarchy

In contrast to the case of lattices where the Embedding Conjecture promises a correspondence of  $k$ -lattices and partition classes which is deeply tied with the polynomial hierarchy, in the case of posets a strict polynomial hierarchy seems insufficient to show an Embedding Theorem for NP. This is discussed in this subsection.

In many cases we can nonetheless collapse the polynomial hierarchy from  $\text{NP}(G, f) \subseteq \text{NP}(G', f')$  with  $(G, f) \not\leq (G', f')$ . For instance, think of the projectively closed classes from the last section (Theorem 4.26).

Carefully analyzing Theorem 3.47, Theorem 3.49, and Theorem 3.51 we easily obtain the following generalizations.

**Theorem 4.32.** *Assume that the polynomial hierarchy is infinite. Let  $(G, f)$  and  $(G', f')$  be  $k$ -posets. If  $\text{NP}(G, f) \subseteq \text{NP}(G', f')$ , then each minimal  $k$ -subchain of  $(G, f)$  occurs as a  $k$ -subchain of  $(G', f')$ .*

**Theorem 4.33.** *Assume that the polynomial hierarchy is infinite. Let  $(G, f)$  and  $(G', f')$  be  $k$ -posets with  $k \geq 3$ . If  $\text{NP}(G, f) \subseteq \text{NP}(G', f')$  then all  $k$ -subposets in  $(G, f)$  having the form as in Figure 3.8 with pairwise different labels  $f(a)$ ,  $f(b)$ , and  $f(c)$  such that there exists at least one element in  $G$  less than  $a$  and  $b$  do also occur in  $(G', f')$ .*

**Theorem 4.34.** *Assume that the polynomial hierarchy is infinite. Let  $(G, f)$  and  $(G', f')$  be  $k$ -posets with  $k \geq 3$ . If  $\text{NP}(G, f) \subseteq \text{NP}(G', f')$  then all  $k$ -subposets in  $(G, f)$  having the form as in Figure 3.9 with pairwise different labels  $f(a)$ ,  $f(b)$ , and  $f(c)$  such that there exists at least one element in  $G$  greater than  $a$  and  $b$  do also occur in  $(G', f')$ .*

From Theorem 4.33 we easily obtain that probably, ENTAILMENT does not reduce to GRAPH EMBEDDING (think of Theorem 3.59 and Example 4.4). Note that the original Theorem 3.49 manages with the weaker assumption that  $\text{NP} \neq \text{coNP}$ .

**Proposition 4.35.** *If  $\text{ENTAILMENT} \leq_m^p \text{GRAPH EMBEDDING}$  then  $\text{NP} = \text{coNP}$ .*

Despite these theorems the following proposition shows that we must be warned to literally take over the Embedding Conjecture for posets.

**Proposition 4.36.** *There exists 3-posets  $(G, f)$  and  $(G', f')$  with  $(G, f) \not\leq (G', f')$  but relative to some oracle, the polynomial hierarchy is infinite and  $\text{NP}(G, f) = \text{NP}(G', f')$ .*





**Fig. 4.9.** The 3-posets critical for extending the Embedding Conjecture

*Proof.* Let  $(G, f)$  be the left and  $(G', f')$  be the right 3-poset in Figure 4.9. Blum and Impagliazzo [BI87] constructed an oracle with  $\text{NP} \cap \text{coNP} = \text{P}$  and the polynomial-time hierarchy is strict. In fact, their proof also shows that there is an oracle  $D$  such that the polynomial-time hierarchy is strict and for all disjoint sets  $A, B \in \text{NP}^D$  there is a set  $C \in \text{P}^D$  with  $A \subseteq C \subseteq \overline{B}$ . Hence, given an  $\text{NP}^D$ -homomorphism  $S$  on  $(G, f)$  we can define an  $\text{NP}^D$ -homomorphism  $S'$  on  $(G', f')$  as  $S'(a') = \overline{S(a)}$ ,  $S'(b') = S(b)$ ,  $S'(c') = C$ , and  $S'(d') = \overline{C}$  where  $C$  belongs to  $\text{P}^D$  with  $S(a) \subseteq C \subseteq \overline{S(b)}$ . This gives  $(G, f, S) \in \text{NP}^D(G', f')$ . The other inclusion holds relativizably by the Embedding Lemma.  $\square$

Does this oracle give evidence against the Embedding Conjecture for lattices as well? We feel that this is not the case since the counterexample strongly depends on the weakness of structure of posets. Moreover, the oracle result affects rather the seemingly insufficient assumption of a strict polynomial-time hierarchy than the correspondence between  $k$ -posets and classes of  $k$ -partitions. For instance, under the assumption that  $\text{UP} \not\subseteq \text{coNP}$ , the counterexample fails.

**Proposition 4.37.** *Let  $(G, f)$  be the left and  $(G', f')$  be the right 3-poset in Figure 4.9. If  $\text{NP}(G, f) = \text{NP}(G', f')$  then  $\text{UP} \subseteq \text{coNP}$ .*

*Proof.* Observe that if  $\text{NP}(G, f) \subseteq \text{NP}(G', f')$  then for every pair  $(A, B)$  of disjoint NP sets there is a set  $C \in \text{NP} \cap \text{coNP}$  with  $A \subseteq C \subseteq \overline{B}$ . So let  $L \in \text{UP}$ , i.e., there are a set  $A \in \text{P}$  and a polynomial  $p$  such that

$$\begin{aligned} x \in L &\iff \|\{y \mid |y| = p(|x|) \wedge \langle x, y \rangle \in A\}\| = 1, \\ x \notin L &\iff \|\{y \mid |y| = p(|x|) \wedge \langle x, y \rangle \in A\}\| = 0. \end{aligned}$$

Define the following sets:

$$\begin{aligned} S_A &= \{(x, z) \mid (\exists y, |y| = p(|x|))[z \leq y \wedge \langle x, y \rangle \in A]\}, \\ T_A &= \{(x, z) \mid (\exists y, |y| = p(|x|))[z > y \wedge \langle x, y \rangle \in A]\}. \end{aligned}$$

Obviously,  $S_A, T_A \in \text{NP}$ ,  $S_A \cap T_A = \emptyset$ , and  $S_A \cup T_A = L \times \Sigma^*$ . Hence, there exists a set  $C \in \text{NP} \cap \text{coNP}$  with  $S_A \subseteq C \subseteq \overline{T_A}$ . Using this set  $C$  as an oracle for binary search, one can determine for each  $x \in \Sigma^*$  a value  $b(x)$  such that  $x \in L \iff \langle x, b(x) \rangle \in A$ . Hence,  $L \in \text{P}^{\text{NP} \cap \text{coNP}} \subseteq \text{coNP}$ .  $\square$

#### 4.4.2 Partition Classes and Leaf Languages

We give another characterization of the classes in refined boolean hierarchy of NP-partitions providing a tool for proving our main result. This characterization is based on the leaf language approach. In some sense the usage of this approach in our setting unifies the approach

of machines that accept partitions (Section 3.7) and the characterization of partition classes over posets by partial functions (Section 4.2).

The leaf language approach is a method of uniform characterization of complexity classes (for a survey see [Vol99]). First we adapt some notions for the case of partition classes (formally, this is a special case of function classes [KSV98]).

**Definition 4.38.** Let  $A = (A_1, \dots, A_k, A_{k+1})$  be a  $(k+1)$ -partition over alphabet  $\Delta$ ,  $k \geq 2$ . The  $k$ -partition  $L$  (over  $\Sigma$ ) belongs to the partition class  $\text{Leaf}_k^{\text{P}}(A)$  if and only if there are functions  $f : \Sigma^* \times \mathbb{N} \rightarrow \Delta$  and  $g : \Sigma^* \rightarrow \mathbb{N}$  both computable in polynomial time such that for all  $x \in \Sigma^*$

1.  $f(x, 0) \dots f(x, g(x)) \in \Delta^* \setminus A_{k+1}$ ,
2.  $c_L(x) = c_A(f(x, 0) \dots f(x, g(x)))$ .

Later the component  $A_{k+1}$  of the partition  $A$  will represent in some sense a subset  $H \subset G$  for the labeled lattice  $(G, f)$ .

Due to Proposition 4.10 it suffices to consider  $k$ -posets  $(D_f, f)$  for partial functions with non-empty domain instead of general  $k$ -posets. We are going to prove a characterization of partition classes  $\text{NP}(D_f, f)$  in terms of partition classes  $\text{Leaf}_k^{\text{P}}(A)$  with  $A$  appropriate. To do this we make the following construction.

Let  $\Delta$  be the alphabet  $\{0, 1, \dots, m\}$  for a given partial function  $f : \{1, 2\}^m \rightarrow \{1, 2, \dots, k\}$ . We also consider the extension  $\bar{f}$  of  $f$  which is a total mapping from  $\{1, 2\}^m \rightarrow \{1, 2, \dots, k+1\}$  defined for all  $w \in \{1, 2\}^m$  as

$$\bar{f}(w) =_{\text{def}} \begin{cases} f(w) & \text{if } w \in D_f, \\ k+1 & \text{if } w \notin D_f. \end{cases}$$

Let  $\tau$  be the function defined for a word  $x \in \Delta^*$  as

$$\tau(x) =_{\text{def}} z_1 \dots z_m \text{ with } z_i = 1 \Leftrightarrow |x|_i > 0 \text{ and } z_i = 2 \Leftrightarrow |x|_i = 0.$$

Finally, define the  $k$ -partition  $A(f)$  over  $\Delta$  by

$$c_{A(f)} =_{\text{def}} \bar{f} \circ \tau.$$

**Theorem 4.39.**  $\text{NP}(D_f, f) = \text{Leaf}_k^{\text{P}}(A(f))$  for every function  $f : \{1, 2\}^m \rightarrow \{1, 2, \dots, k\}$  with non-empty domain.

*Proof.* Let  $f : \{1, 2\}^m \rightarrow \{1, 2, \dots, k\}$  with  $D_f \neq \emptyset$ .

$\subseteq$ : Let  $A \in \text{NP}(D_f, f)$ , i.e., there exist sets  $B_1, \dots, B_m \in \text{NP}$  such that for all  $x \in \Sigma^*$ ,  $(c_{B_1}(x), \dots, c_{B_m}(x)) \in D_f$  and  $c_A(x) = f(c_{B_1}(x), \dots, c_{B_m}(x))$  for all  $x \in \Sigma^*$ . Then there are sets  $C_i \in \text{P}$  and, without loss of generality, one polynomial  $p$  such that for all  $x \in \Sigma^*$ ,

$$x \in B_i \iff \|\{y \mid |y| = p(|x|) \wedge (x, y) \in C_i\}\| > 0.$$

Define functions  $s$  and  $t$  for all  $x \in \Sigma^*$  as

$$t(x) =_{\text{def}} m2^{p(|x|)} - 1$$

and for all  $j \in \mathbb{N}$  with  $j \leq t(|x|)$

$$s(x, j) =_{\text{def}} \begin{cases} i & \text{if } (i-1)2^{p(|x|)} \leq j < i2^{p(|x|)} \text{ and } \langle x, j - (i-1)2^{p(|x|)} \rangle \in C_i, \\ 0 & \text{if } (i-1)2^{p(|x|)} \leq j < i2^{p(|x|)} \text{ and } \langle x, j - (i-1)2^{p(|x|)} \rangle \notin C_i. \end{cases}$$

Clearly,  $s$  and  $t$  are computable in polynomial time, and for all  $i \in \{1, 2, \dots, m\}$  it holds

$$x \in B_i \iff |s(x, 0) \dots s(x, t(x))|_i > 0.$$

Hence we have for all  $x \in \Sigma^*$ ,

$$\tau(s(x, 0) \dots s(x, t(x))) = (c_{B_1}(x), \dots, c_{B_m}(x))$$

for all  $x \in \Sigma^*$ . This gives  $s(x, 0) \dots s(x, t(x)) \in \Delta^* \setminus A(\bar{f})_{k+1}$  and

$$c_A(x) = (f \circ \tau)(s(x, 0) \dots s(x, t(x))) = c_{A(f)}(s(x, 0) \dots s(x, t(x))).$$

Thus,  $A \in \text{Leaf}_k^{\text{P}}(A(f))$ .

$\supseteq$ : Let  $A \in \text{Leaf}_k^{\text{P}}(A(f))$ , and let  $s$  and  $t$  be the witnessing functions. Consider the sets

$$B_i =_{\text{def}} \{x \in \Sigma^* \mid \|\{j \mid j \leq t(x) \wedge s(x, j) = i\}\| > 0\}$$

for  $i \in \{1, 2, \dots, m\}$ . Obviously,  $B_1, \dots, B_m \in \text{NP}$ . Let  $x$  be an arbitrary word in  $\Sigma^*$ . Since  $s(x, 0) \dots s(x, t(x)) \in \Delta^* \setminus A(f)_{k+1}$ , we get

$$(c_{B_1}(x), \dots, c_{B_m}(x)) = \tau(s(x, 0) \dots s(x, t(x))) \in D_f.$$

Furthermore, it is easily seen that

$$\begin{aligned} c_{A(f)}(s(x, 0) \dots s(x, t(x))) &= (f \circ \tau)(s(x, 0) \dots s(x, t(x))) \\ &= f(c_{B_1}(x), \dots, c_{B_m}(x)) = c_A(x). \end{aligned}$$

Consequently,  $A \in \text{NP}(D_f, f)$ . □

#### 4.4.3 Relativizing Partition Classes

We are going to prove our relativized Embedding Theorem.

Partition classes that are captured by the following type of partitions are of particular interest in the forthcoming. The notion is based on the work of Hertrampf [Her95] who introduced it for the case of sets.

Let  $\text{sgn} : \mathbb{N} \rightarrow \{0, 1\}$  be the sign function, i.e.,  $\text{sgn}(x) = \min\{x, 1\}$  for all  $x \in \mathbb{N}$ .

**Definition 4.40.** Any  $k$ -partition  $A$  over  $\Delta = \{a_1, \dots, a_m\}$  is said to be of *simple counting type* if and only if for all  $x, y \in \Delta^*$ ,

$$(\text{sgn}(|x|_{a_1}), \dots, \text{sgn}(|x|_{a_m})) = (\text{sgn}(|y|_{a_1}), \dots, \text{sgn}(|y|_{a_m})) \implies c_A(x) = c_A(y).$$

Observe that the partitions  $A(f)$  in Theorem 4.39 are partitions of simple counting type.

The reason why partitions of this type are important is Lemma 4.41 that brings together *mutatis mutandis* results from the works [BCS92, Ver93, KSV98, Her95, CHVW98]. For this lemma we need further notions.

For any  $k$ -partition  $A$  of simple counting type over  $\Delta = \{a_1, \dots, a_m\}$  let  $T_A : \mathbb{N}^m \rightarrow \{1, 2, \dots, k\}$  be the function defined for all  $n_1, \dots, n_m \in \mathbb{N}$  as

$$T_A(n_1, \dots, n_m) =_{\text{def}} c_A(a_1^{n_1} \dots a_m^{n_m}).$$

A function  $p : \mathbb{N}^m \rightarrow \mathbb{N}$  is a positive linear combination of multinomial coefficients iff there are  $z \in \mathbb{N}^m$  and  $\alpha_t \in \mathbb{N}$  such that for all  $n \in \mathbb{N}^m$

$$p(n) = \sum_{t \leq z} \alpha_t \binom{n}{t}.$$

A relativization of a leaf class means that the deterministic polynomial-time machines computing the defining functions  $f$  and  $g$  have oracle access.

**Lemma 4.41.** *Let  $A$  and  $B$  be any  $(k+1)$ -partitions of simple counting type over an  $m$ -elementary alphabet  $\Delta = \{a_1, \dots, a_m\}$ . The following are equivalent.*

1.  $\text{Leaf}_k^P(A)^C \subseteq \text{Leaf}_k^P(B)^C$  for all oracles  $C$ .
2. There are functions  $p_1, \dots, p_m : \mathbb{N}^m \rightarrow \mathbb{N}$  which are positive linear combinations of multinomial coefficients such that for all  $n_1, \dots, n_m \in \mathbb{N}$  with  $a_1^{n_1} \dots a_m^{n_m} \in \Delta^* \setminus A_{k+1}$ ,

$$T_A(n_1, \dots, n_m) = T_B(p_1(n_1, \dots, n_m), \dots, p_m(n_1, \dots, n_m)).$$

**Theorem 4.42.** *Let  $(G, f)$  and  $(G', f')$  be  $k$ -posets. Then  $(G, f) \leq (G', f')$  if and only if for all oracles  $C$ ,  $\text{NP}^C(G, f) \subseteq \text{NP}^C(G', f')$ .*

*Proof.*

$\Rightarrow$ : Follows from the Embedding Lemma and since NP is relativizably closed under union and intersection.

$\Leftarrow$ : We can restrict ourselves to  $k$ -posets  $(D_f, f)$  for partial functions  $f$  having a non-empty domain. So Theorem 4.39 enables us to apply Lemma 4.41. Note that the proof of Theorem 4.39 relativizes.

Before making an explicit use of Lemma 4.41, we subtly have to verify that for every  $m$ -ary partial function  $f$  and for every  $m' > m$  there is a  $m'$ -ary partial function  $f'$  with  $(D_f, f) \equiv (D_{f'}, f')$ . Let  $m' > m$ . Consider the mapping  $\eta : \{1, 2\}^{m'} \rightarrow \{1, 2\}^m$  given for each  $w$  as

$$\eta(w_1 \dots w_m w_{m+1} \dots w_{m'}) =_{\text{def}} w_1 \dots w_m.$$

Define  $f' =_{\text{def}} f \circ \eta$ , that is  $f' : \{1, 2\}^{m'} \rightarrow \{1, \dots, k\}$  and  $f'(w_1, \dots, w_m w_{m+1} \dots w_{m'}) = f(w_1 \dots w_m)$ . Then,  $(D_f, f) \leq (D_{f'}, f')$  is immediately seen and  $(D_f, f) \geq (D_{f'}, f')$  is witnessed by  $\eta$ . Hence, it is sufficient to prove the assertion of the theorem only for  $k$ -posets represented by partial functions of the same arity.

Let  $f, f' : \{1, 2\}^m \rightarrow \{1, 2, \dots, k\}$  be partial functions with non-empty domain. Suppose that  $\text{NP}^C(D_f, f) \subseteq \text{NP}^C(D_{f'}, f')$  for all oracles  $C$ . We have to show that there is

a monotonic mapping  $\varphi : D_f \rightarrow D_{f'}$  such that  $f(w) = f'(\varphi(w))$  for every  $w \in D_f$ . By Theorem 4.39 for all oracles  $C$  it holds that  $\text{NP}^C(D_f, f) = \text{Leaf}_k^P(A(f))^C$  and  $\text{NP}^C(D_{f'}, f') = \text{Leaf}_k^P(A(f'))^C$ . Since  $A(\bar{f})$  and  $A(\bar{f}')$  are  $k$ -partitions over the same alphabet  $\Delta = \{0, 1, \dots, m\}$  of simple counting type, we can apply Lemma 4.41. So, let  $p_0, p_1, \dots, p_m$  be functions as given in Lemma 4.41. Since these functions are positive linear combinations of multinomial coefficients, in particular these functions are monotonic with respect to vector-ordering. For  $a \in \{1, 2\}$  let  $a' = 1$  if  $a = 1$ , and  $a' = 0$  if  $a = 2$ . Then it holds for all  $w \in D_f$ :

$$\begin{aligned}
c_{A(f)}(1^{w'_1} 2^{w'_2} \dots m^{w'_m}) &= T_{A(f)}(0, w'_1, \dots, w'_m) && \text{(by Definition of } T_{A(f)}\text{)} \\
&= T_{A(f')} (p_0(0, w'_1, \dots, w'_m), \dots, p_m(0, w'_1, \dots, w'_m)) && \text{(by Lemma 4.41)} \\
&= c_{A(f')} \left( 0^{p_0(0, w'_1, \dots, w'_m)} 1^{p_1(0, w'_1, \dots, w'_m)} \dots m^{p_m(0, w'_1, \dots, w'_m)} \right) && \text{(by Definition of } T_{A(f')}\text{)} \\
&= c_{A(f')} \left( 1^{p_1(0, w'_1, \dots, w'_m)} 2^{p_2(0, w'_1, \dots, w'_m)} \dots m^{p_m(0, w'_1, \dots, w'_m)} \right) && \text{(} A(f') \text{ is of simple counting type)}
\end{aligned}$$

Now, define  $\varphi$  for every  $w \in D_f$  as

$$\varphi(w_1 \dots w_m) =_{\text{def}} \tau \left( 1^{p_1(0, w'_1, \dots, w'_m)} 2^{p_2(0, w'_1, \dots, w'_m)} \dots m^{p_m(0, w'_1, \dots, w'_m)} \right).$$

We have to show that

1.  $\varphi$  maps  $D_f$  to  $D_{f'}$ ,
2.  $\varphi$  is monotonic,
3.  $f(w) = f'(\varphi(w))$  for all  $w \in D_f$ .

This can be seen as follows.

1. Let  $w \in D_f$ , i.e.,  $1^{w'_1} \dots m^{w'_m} \in \Delta^* \setminus A(f)_{k+1}$ . Thus by the arguments above the word  $1^{p_1(0, w'_1, \dots, w'_m)} \dots m^{p_m(0, w'_1, \dots, w'_m)}$  belongs to  $\Delta^* \setminus A(\bar{f}')_{k+1}$ . Hence,  $\varphi(w) = \tau \left( 1^{p_1(0, w'_1, \dots, w'_m)} \dots m^{p_m(0, w'_1, \dots, w'_m)} \right) \in D_{f'}$  by definition of  $A(\bar{f}')$ .
2. Let  $v \leq w$ . It is enough to show that  $\varphi(w)_j = 2$  whenever  $\varphi(v)_j = 2$  for all  $j \in \{1, 2, \dots, m\}$ . But this is immediate from the following facts:
  - $\varphi(v)_j = 2 \iff p_j(0, v'_1, \dots, v'_m) = 0$ , by construction of  $\tau$ ,
  - $p_j(0, w'_1, \dots, w'_m) \leq p_j(0, v'_1, \dots, v'_m)$ , since  $v_j \leq w_j$  implies  $w'_j \leq v'_j$  and  $p_j$  is monotonic with respect to the vector-ordering.

Thus, we have shown  $\varphi(v) \leq \varphi(w)$ .

3.  $w \in D_f$ . Then we can conclude

$$\begin{aligned}
f(w) &= c_{A(f)}(1^{w'_1} \dots m^{w'_m}) = c_{A(f')} \left( 1^{p_1(0, w'_1, \dots, w'_m)} \dots m^{p_m(0, w'_1, \dots, w'_m)} \right) \\
&= (f' \circ \tau) \left( 1^{p_1(0, w'_1, \dots, w'_m)} \dots m^{p_m(0, w'_1, \dots, w'_m)} \right) = f'(\varphi(w))
\end{aligned}$$

Thus, the proof of Theorem 4.42 is complete.  $\square$

The theorem indicates that it is reasonable to assume that except those inclusions of partition classes over NP that are induced by the relation  $\leq$  no further inclusions hold since each proof of a further inclusion must use non-relativizable proof-techniques. Moreover, the theorem gives more evidence to the Embedding Conjecture (for lattices).

**Corollary 4.43.** *Let  $(G, f)$  and  $(G', f')$  be  $k$ -lattices. Then,  $(G, f) \leq (G', f')$  if and only if for all oracles  $C$ ,  $\text{NP}(G, f)^C \subseteq \text{NP}(G', f')^C$ .*

## 5. Some Applications

After exploring structural properties of the boolean hierarchy of  $k$ -partitions over NP and its refined version we want to demonstrate in this chapter that our studies are not only interesting in their own, e.g., as a framework for capturing the complexity of classification problems but have interesting ties with other research in computational complexity. We discuss the relationships to the study of separable NP sets, we show that our approach to consider classes generated by  $k$ -posets lead in the case  $k = 2$  to very fine subhierarchies in low levels of the boolean hierarchy of sets over NP, and we resolve in some sense an open question concerning certain possibilities to reduce output cardinalities of multi-valued NP functions.

### 5.1 Separability within NP

The study of partition classes in the context of the boolean hierarchy is very closely related to the study of separability notions. In this section we emphasize how successfully both studies can interact.

#### 5.1.1 Separability Notions

The notion of separability is a very fundamental one which originally goes back to Lusin who created by introducing it in descriptive set theory a very influential notion (for a list of separation theorems see [Kec95]).

Typically, separability means the following: Let  $\mathcal{K}_1$  and  $\mathcal{K}_2$  be classes of subsets of  $M$  and let  $\mathcal{K}_2$  be closed under complements. We say that two disjoint sets  $A$  and  $B$  belonging to  $\mathcal{K}_1$  are separable by sets from  $\mathcal{K}_2$  if there exist a set  $C \in \mathcal{K}_2$  such that  $A \subseteq C$  and  $B \subseteq \overline{C}$ . We say that the two disjoint sets are inseparable in  $\mathcal{K}_2$  if they are not separable by sets from  $\mathcal{K}_2$ . This notion becomes interesting if  $\mathcal{K}_2$  is not greater than  $\mathcal{K}_1$ .

Separability has been extensively investigated in recursion theory. It has been used to strengthen that  $\text{REC} \subset \text{RE}$  by proving that there exists a pair of disjoint recursively enumerable sets that are not separable by recursive sets [Kle50, Tra53] (for a stronger result see [Sho58]). In contrast to this, it is not hard to show that every pair of disjoint complements of recursively enumerable sets is separable by recursive sets. In fact, we have extended this property to show that the Embedding Theorem for the recursively enumerable sets cannot hold (Theorem 3.30). Furthermore, separability is deeply tied with, e.g., creative sets [Kle50, Usp53] or essential undecidability of formal systems [Tar49].

In complexity theory, finally, separability has also been broadly applied. In 1988, Grollmann and Selman [GS88] showed that weak one-way functions<sup>1</sup> exist if and only if there is

---

<sup>1</sup> A weak one-way function is one that has some easy-to-compute extension but no easy-to-invert extension.

a pair of disjoint NP sets that is inseparable in P. Whether the latter is possible has subsequently been examined further in [FR94, FFNR96, MV96]. Hemaspaandra *et al.* [HHN<sup>+</sup>95] pointed out connections between separability and selectivity notions. In particular, they proved that all NP-selective sets are P-selective if and only if all pairs of disjoint NP sets are separable in P. Furthermore separability has been studied in the complexity-theoretic settings of lower bounds for proof systems [Raz94, Raz95, KM98], complexity of Craig interpolants [SP98], P-superterse sets [Bei88], and witness-isomorphic reductions [FHT97].

The notion of separability mentioned so far always supposes pairs of disjoint sets. In order to make the notion applicable to general pairs we introduce two reasonable extensions.

**Definition 5.1.** Let  $\mathcal{K}$  be a class of subsets of  $M$ . Let  $A$  and  $B$  be subsets of  $M$ .

1. The pair  $(A, B)$  is said to be  $\mathcal{K}$ -separable if and only if there exist sets  $C, D \in \mathcal{K}$  such that  $A \subseteq C$ ,  $B \subseteq D$ ,  $C \cup D = M$ , and  $A \cap B = C \cap D$ .
2. The pair  $(A, B)$  is said to be *weakly*  $\mathcal{K}$ -separable if and only if there exists a set  $C \in \mathcal{K}$  such that  $A \setminus B \subseteq C$  and  $B \setminus A \subseteq \overline{C}$ .

The definition of  $\mathcal{K}$ -separability is motivated by the following correspondence to the refined boolean hierarchy of  $\mathcal{K}$ -partitions.

**Proposition 5.2.** Let  $\mathcal{K}$  be a class with  $\emptyset, M \in \mathcal{K}$  which is closed under intersection and union. Let  $\mathfrak{S}_0$  and  $\mathfrak{S}_\infty$  be the 4-poset presented in Figure 5.1.

1.  $\mathcal{K}(\mathfrak{S}_0) = \{ (A, B, \overline{A \cup B}, A \cap B) \mid A, B \in \mathcal{K} \}$ .
2.  $\mathcal{K}(\mathfrak{S}_\infty) = \{ (A, B, \overline{A \cup B}, A \cap B) \mid A, B \in \mathcal{K} \text{ and } (A, B) \text{ is } \mathcal{K}\text{-separable} \}$ .
3. All pairs of  $\mathcal{K}$  sets are  $\mathcal{K}$ -separable if and only if  $\mathcal{K}(\mathfrak{S}_0) = \mathcal{K}(\mathfrak{S}_\infty)$ .

Note that if we only consider pairs of disjoint sets then we have a similar equivalence, namely by the equality of the partition classes generated by the 3-posets from Figure 4.9.

The following propositions are easily seen from the definitions.

**Proposition 5.3.** Let  $\mathcal{K}$  be a class of subsets of  $M$ . Let  $A$  and  $B$  be subsets of  $M$ .

1.  $(A, B)$  is  $\mathcal{K}$ -separable if and only if  $(B, A)$  is  $\mathcal{K}$ -separable.
2. If  $(A, B)$  is  $\mathcal{K}$ -separable then  $(A, B)$  is weakly  $\mathcal{K}$ -separable.
3. Let  $A \cap B = \emptyset$ .  $(A, B)$  is  $\mathcal{K}$ -separable if and only if  $(A, B)$  is weakly  $\mathcal{K}$ -separable.

**Proposition 5.4.** Let  $\mathcal{K} \subseteq \mathcal{C}$ .

1. All pairs  $(A, B)$  of  $\mathcal{K}$  sets are  $\text{BC}(\mathcal{C})$ -separable.
2. All pairs  $(A, B)$  of  $\mathcal{K}$  sets are weakly  $\mathcal{C}$ -separable.

*Proof.*

1. Set  $C = A$  and  $D = B \cup \overline{A}$  in Definition 5.1.1.
2. Set  $C = A$  in Definition 5.1.2.

□

The next result can be obtained by carefully analyzing the proof of Lemma 3.48. A set  $A$  is 2- $\{\wedge, \vee\}$ -tt-self-reducible, if there exists a polynomial-time computable function  $f$  computing for every input  $x \in \Sigma^*$  a triple  $(\circ, x_0, x_1)$  with  $x_0, x_1 \in \Sigma^{\leq |x|-1}$  and  $\circ \in \{\wedge, \vee\}$  such that  $x \in A \Leftrightarrow x_0 \in A \circ x_1 \in A$ .





**Fig. 5.1.** The 4-posets  $\mathfrak{G}_0$  (on the left) and  $\mathfrak{G}_\infty$  (on the right)

**Theorem 5.5.** *Let  $\mathcal{K}$  be closed under  $\leq_m^p$  and let  $\mathcal{K}$  possess a  $\leq_m^p$ -complete set that is 2- $\{\wedge, \vee\}$ -tt-self-reducible. If all pairs of  $\mathcal{K}$  sets are weakly  $\mathcal{C}$ -separable, then  $\mathcal{K} \subseteq \text{P}^{\mathcal{C}}$ .*

Together with Proposition 5.4 we conclude the following.

**Corollary 5.6.** *Let  $\mathcal{K}$  be closed under  $\leq_m^p$  and let  $\mathcal{K}$  possess a  $\leq_m^p$ -complete set that is 2- $\{\wedge, \vee\}$ -tt-self-reducible. Then, the following statements are equivalent.*

1. All pairs of  $\mathcal{K}$  sets are  $\text{P}^{\mathcal{C}}$ -separable.
2. All pairs of  $\mathcal{K}$  sets are weakly  $\text{P}^{\mathcal{C}}$ -separable.
3.  $\mathcal{K} \subseteq \text{P}^{\mathcal{C}}$ .

The low and the high hierarchy within NP were introduced by Schöning [Sch83]. Define  $\text{Low}_k$  to be the class of all NP sets  $A$  such that  $\Sigma_k^p(A) = \Sigma_k^p$ . Let  $\text{High}_k$  be the class of all sets  $A \in \text{NP}$  such that  $\Sigma_k^p(A) = \Sigma_{k+1}^p$ . The following is well known.

- $\text{Low}_0 = \text{P}$  and  $\text{Low}_1 = \text{NP} \cap \text{coNP}$ .
- $\text{P}^{\text{Low}_k} = \text{Low}_k$  and  $\text{P}^{\text{High}_k} = \text{High}_k$ .
- $\text{NP} = \text{Low}_k \iff \text{PH} = \Sigma_k^p$  and  $\text{NP} = \text{High}_k \iff \text{PH} = \Sigma_k^p$ .

So the following is immediate from Corollary 5.6 since SATISFIABILITY is clearly 2- $\{\wedge, \vee\}$ -tt-self-reducible.

**Corollary 5.7.**

1. All pairs of NP sets are (weakly)  $\text{Low}_k$ -separable if and only if  $\text{PH} = \Sigma_k^p$ .
2. All pairs of NP sets are (weakly)  $\text{High}_k$ -separable if and only if  $\text{PH} = \Sigma_k^p$ .

The similar result can be obtained for pairs of coNP sets since TAUTOLOGY is 2- $\{\wedge, \vee\}$ -tt-self-reducible. In particular, we thus have that all pairs of NP sets are P-separable if and only if all pairs of coNP sets are P-separable, and both is equivalent to  $\text{P} = \text{NP}$ . This symmetry is remarkable since it is not known to hold for pairs of disjoint sets (see [FFNR96, MV96]).

We now turn to separability for disjoint sets. Note that the following theorem for the case  $\mathcal{K} = \text{P}$  and  $\mathcal{C} = \text{NP} \cap \text{coNP}$  is just Proposition 4.37. The theorem generalizes the proof of Grollmann and Selman [GS88] who obtained a similar result for  $\mathcal{C} = \mathcal{K} = \text{P}$ .

**Theorem 5.8.** *Let  $\mathcal{K} \subseteq \mathcal{C}$  and let  $\mathcal{K}$  be closed under  $\leq_m^p$ . If all pairs of disjoint  $U \cdot \mathcal{K}$  sets are  $\mathcal{C}$ -separable, then  $U \cdot \mathcal{K} \subseteq \text{P}^{\mathcal{C}}$ .*

*Proof.* Let  $A \in U \cdot \mathcal{K}$ , i.e., there are a set  $B \in \mathcal{K}$  and a polynomial  $p$  such that

$$\begin{aligned} x \in A &\iff \|\{y \mid |y| = p(|x|) \wedge \langle x, y \rangle \in \mathcal{K}\}\| = 1, \\ x \notin A &\iff \|\{y \mid |y| = p(|x|) \wedge \langle x, y \rangle \in \mathcal{K}\}\| = 0. \end{aligned}$$

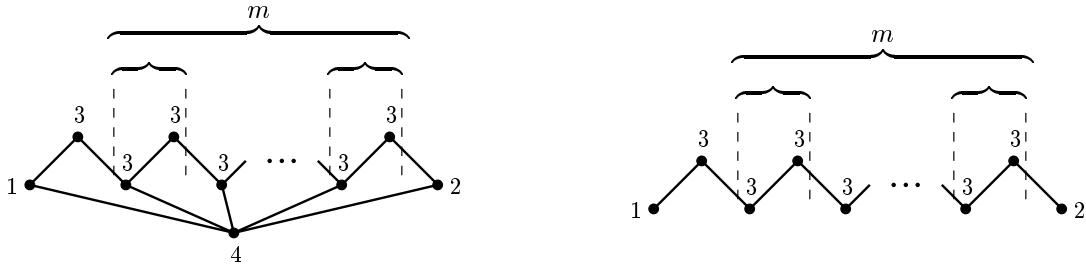

Fig. 5.2. The labeled posets  $\mathfrak{S}_m$  (on the left) and  $\mathfrak{S}_m^0$  (on the right) for  $m \in \mathbb{N}$

Define the following sets:

$$S_B = \{(x, z) \mid (\exists y, |y| = p(|x|))[z \leq y \wedge \langle x, y \rangle \in B]\}$$

$$T_B = \{(x, z) \mid (\exists y, |y| = p(|x|))[z > y \wedge \langle x, y \rangle \in B]\}$$

Obviously,  $S_B, T_B \in \mathcal{U} \cdot \mathcal{K}$ ,  $S_B \cap T_B = \emptyset$ , and  $S_B \cup T_B = A \times \Sigma^*$ . Hence, there exists a set  $C, D \in \mathcal{C}$  with  $D = \overline{C}$  and  $S_B \subseteq C \subseteq \overline{T_B}$ . Using this set  $C$  as an oracle for binary search, one can determine for each  $x \in \Sigma^*$  a value  $b(x)$  such that  $x \in A \iff \langle x, b(x) \rangle \in B$ . Hence,  $A \in \mathcal{P}^C$ .  $\square$

**Corollary 5.9.** *Let  $\mathcal{K} \subseteq \mathcal{P}^C$  and let  $\mathcal{K}$  be closed under  $\leq_m^p$ . Then the following statements are equivalent.*

1. All pairs of  $\mathcal{U} \cdot \mathcal{K}$  sets are  $\mathcal{P}^C$ -separable.
2. All pairs of disjoint  $\mathcal{U} \cdot \mathcal{K}$  sets are  $\mathcal{P}^C$ -separable.
3.  $\mathcal{U} \cdot \mathcal{K} \subseteq \mathcal{P}^C$ .

**Corollary 5.10.** *The following statements are equivalent.*

1. All pairs of UP sets are P-separable.
2. All pairs of disjoint UP sets are P-separable.
3.  $\text{P} = \text{UP}$ .

**Corollary 5.11.**

1. If all pairs of disjoint NP sets are  $\text{Low}_k$ -separable then  $\text{UP} \subseteq \text{Low}_k$ .
2. If all pairs of disjoint NP sets are  $\text{High}_k$ -separable then  $\text{UP} \subseteq \text{High}_k$ .

Sheu and Long [SL96] proved that for all  $k \in \mathbb{N}$  there are oracles  $C$  and  $D$  such that  $\text{UP} \not\subseteq \text{Low}_k$  relative to  $C$ , and  $\text{UP} \not\subseteq \text{High}_k$  relative to  $D$ . So we obtain that there exist relativized worlds where all pairs of disjoint NP sets are not  $\text{Low}_k$ -separable as well as there exist relativized worlds where all pairs of disjoint NP sets are not  $\text{High}_k$ -separable.

### 5.1.2 A Quantitative Approach to Separability

Proposition 5.2 shows that the 4-poset  $\mathfrak{S}_0$  represents the class of all pairs of  $\mathcal{K}$  sets and that the 4-poset  $\mathfrak{S}_\infty$  represents the class of  $\mathcal{K}$ -separable pairs of  $\mathcal{K}$  sets. However, there are further 4-posets in between  $\mathfrak{S}_0$  and  $\mathfrak{S}_\infty$  with respect to our relation  $\leq$  on labeled posets, namely, all the 4-posets  $\mathfrak{S}_m$  in Figure 5.2 (in the case that we consider disjoint sets, for all  $m \in \mathbb{N} \cup \{\infty\}$ , let  $\mathfrak{S}_m^0$  be the 3-poset that emerges from  $\mathfrak{S}_m$  by deleting the minimum of the poset). This motivates the following definition.

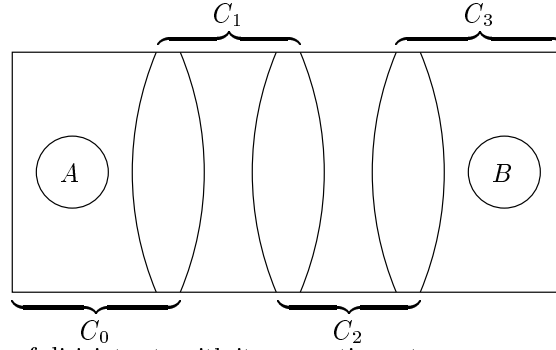

Fig. 5.3. A 3-separable pair of disjoint sets with its separating sets

**Definition 5.12.** Let  $\mathcal{K}$  be a class of subsets of  $M$ . Let  $A$  and  $B$  be subsets of  $M$ . Let  $m \in \mathbb{N}$ . The pair  $(A, B)$  is said to be  $m$ -separable in  $\mathcal{K}$  if and only if there exist sets  $C_0, C_1, \dots, C_m \in \mathcal{K}$  such that the following conditions are satisfied:

1.  $\bigcup_{j=0}^m C_j = M$ ,
2.  $A \cap B \subseteq C_j$  for all  $j \in \{0, 1, \dots, m\}$ ,
3.  $C_i \cap C_k = A \cap B$  for all  $i, j \in \{0, 1, \dots, m\}$  with  $|i - j| \geq 2$ ,
4.  $A \setminus B \subseteq C_0 \setminus C_1$  and  $B \setminus A \subseteq C_m \setminus C_{m-1}$ .

We say that the sets  $C_0, C_1, \dots, C_m$   $m$ -separate the pair  $(A, B)$ .

Figure 5.3 shows an example of a pair of disjoint sets which is 3-separable.

**Proposition 5.13.** Let  $\mathcal{K}$  be a class with  $\emptyset, M \in \mathcal{K}$  and which is closed under intersection and union. Let  $m \in \mathbb{N}$ . Let  $\mathfrak{S}_m$  and  $\mathfrak{S}_m^0$  be the labeled posets presented in Figure 5.2. then the following is true.

1.  $\mathcal{K}(\mathfrak{S}_m) = \{ (A, B, \overline{A \cup B}, A \cap B) \mid A, B \in \mathcal{K} \text{ and } (A, B) \text{ is } m\text{-separable in } \mathcal{K} \}$ .
2.  $\mathcal{K}(\mathfrak{S}_m^0) = \{ (A, B, \overline{A \cup B}) \mid A, B \in \mathcal{K}, A \cap B = \emptyset \text{ and } (A, B) \text{ is } m\text{-separable in } \mathcal{K} \}$ .

The notion of  $m$ -separability induces a hierarchy which contains each pair of sets from  $\mathcal{K}$ .

**Proposition 5.14.** Let  $\mathcal{K}$  be such that  $\emptyset, M \in \mathcal{K}$  and which is closed under intersection and union. Let  $A$  and  $B$  subsets of  $M$ .

1.  $(A, B)$  is 0-separable in  $\mathcal{K}$ .
2. For every  $m \in \mathbb{N}$ , if  $(A, B)$  is  $(m + 1)$ -separable in  $\mathcal{K}$  then  $(A, B)$  is  $m$ -separable in  $\mathcal{K}$ .
3. If  $(A, B)$  is  $\mathcal{K}$ -separable then  $(A, B)$  is  $m$ -separable in  $\mathcal{K}$  for all  $m \in \mathbb{N}$ .

*Proof.*

1. Set  $C_0 = M$  in Definition 5.12.
2. Follows from Proposition 5.13 and the Embedding Lemma.
3. Follows from Proposition 5.2 and the Embedding Lemma.

□

It depends on the properties of the class  $\mathcal{K}$  how many levels the hierarchy concretely has. For instance, by Proposition 5.4, if  $\mathcal{K}$  is closed under complements then each pair of  $\mathcal{K}$  sets is  $\mathcal{K}$ -separable. Generally one can prove the following theorem specifying connections in the structure of the hierarchy.

**Theorem 5.15.** *Let  $\mathcal{K}$  be a class with  $\emptyset, M \in \mathcal{K}$  and which is closed under intersection and union. Let  $m \in \mathbb{N}$ . If all pairs of  $\mathcal{K}$  sets that are  $m$ -separable in  $\mathcal{K}$  are also  $(m+1)$ -separable in  $\mathcal{K}$ , then they all are  $n$ -separable in  $\mathcal{K}$  for all  $n \geq m$ .*

*Proof.* Suppose that all pairs of  $\mathcal{K}$  sets being  $m$ -separable in  $\mathcal{K}$  are  $(m+1)$ -separable in  $\mathcal{K}$ . It suffices to show that then all pairs of  $\mathcal{K}$  sets being  $(m+1)$ -separable in  $\mathcal{K}$  are  $(m+2)$ -separable in  $\mathcal{K}$  as well. The theorem then follows by induction. Let the pair  $(A, B)$  of  $\mathcal{K}$  sets be  $(m+1)$ -separable. Let  $C_0^{m+1}, C_1^{m+1}, \dots, C_{m+1}^{m+1}$  be the sets that  $(m+1)$ -separate  $(A, B)$  in  $\mathcal{K}$ . Then the pair  $(C_0^{m+1}, B)$  is  $m$ -separable in  $\mathcal{K}$  as is easily seen by setting  $D_0^m = C_0^{m+1} \cup C_1^{m+1}$  and  $D_i^m = C_{i+1}^{m+1}$  for  $i \in \{1, 2, \dots, m\}$ . By our supposition,  $(C_0^{m+1}, B)$  is also  $(m+1)$ -separable in  $\mathcal{K}$ . Let  $D_0^{m+1}, D_1^{m+1}, \dots, D_{m+1}^{m+1}$  be the sets in  $\mathcal{K}$  that  $(m+1)$ -separate  $(C_0^{m+1}, B)$ . Define the sets  $E_j^{m+1}$  for  $j \in \{0, 1, \dots, m+1\}$  as follows:

$$E_j^{m+1} =_{\text{def}} \left( D_j^m \cap \bigcup_{r=0}^j D_r^{m+1} \right) \cup \left( D_{j-1}^m \cap \bigcup_{r=j}^{m+1} D_r^{m+1} \right)$$

where we consider both  $D_{-1}^m$  and  $D_{m+1}^m$  to be the empty set. Clearly, all  $E_j^{m+1}$  are in  $\mathcal{K}$ .

**Claim.**  $(C_0^{m+1}, B)$  is  $(m+1)$ -separated in  $\mathcal{K}$  by  $E_0^{m+1}, E_1^{m+1}, \dots, E_{m+1}^{m+1}$ .

*Proof of the claim.* We have to show that all conditions in Definition 5.12 are fulfilled.

1. Let  $x \in M$ . Since  $\bigcup_{j=0}^m D_j^m = M$  and  $\bigcup_{j=0}^{m+1} D_j^{m+1} = M$  there exist indexes  $i$  and  $j$  with  $x \in D_i^m \cap D_j^{m+1}$ . For such  $i$  and  $j$  we clearly have that if  $i > j$  then  $x \in E_i^{m+1}$  else  $x \in E_{i+1}^{m+1}$ .
2. That  $C_0^{m+1} \cap B \subseteq E_j^{m+1}$  for all  $j \in \{0, 1, \dots, m+1\}$  is obvious.
3. We have to show that  $E_i^{m+1} \cap E_j^{m+1} \subseteq C_0^{m+1} \cap B$  for all  $i, j$  with  $|i - j| \geq 2$ . Without loss of generality, let  $i < j$ . Using the distributive law it is enough to conclude that

$$\begin{aligned} D_i^m \cap D_j^m \cap \bigcup_{r=0}^i D_r^{m+1} &\subseteq C_0^{m+1} \cap B \\ D_{i-1}^m \cap D_j^m \cap \bigcup_{r=0}^{m+1} D_r^{m+1} &\subseteq C_0^{m+1} \cap B \\ D_i^m \cap D_{j-1}^m \cap \left( \bigcup_{r=0}^i D_r^{m+1} \right) \cap \left( \bigcup_{r=j}^{m+1} D_r^{m+1} \right) &\subseteq C_0^{m+1} \cap B \\ D_{i-1}^m \cap D_{j-1}^m \cap \bigcup_{r=j}^{m+1} D_r^{m+1} &\subseteq C_0^{m+1} \cap B \end{aligned}$$

4. On the one hand we easily calculate that

$$\begin{aligned} E_0^{m+1} \setminus E_1^{m+1} &= (D_0^m \cap D_0^{m+1}) \setminus (D_1^m \cup D_1^{m+1}) \\ &= (D_0^m \setminus D_1^m) \cap D_0^{m+1} \cap (D_0^{m+1} \setminus D_1^{m+1}) \cap D_0^m \supseteq C_0^{m+1} \cap B. \end{aligned}$$

On the other hand we conclude

$$E_{m+1}^{m+1} \setminus E_m^{m+1} = (D_m^m \cap D_{m+1}^{m+1}) \setminus D_m^{m+1} = D_m^m \cap (D_{m+1}^{m+1} \setminus D_m^{m+1}) \supseteq C_0^{m+1} \cap B.$$

This shows the claim.

Now we define the sets  $C_j^{m+2}$  for all  $j \in \{0, 1, \dots, m+2\}$  as follows:

$$C_j^{m+2} =_{\text{def}} \begin{cases} C_0^{m+1} & \text{if } j = 0, \\ E_0^{m+1} \cap C_1^{m+1} & \text{if } j = 1, \\ E_{j-1}^{m+1} & \text{if } j \geq 2. \end{cases}$$

Since  $E_0^{m+1} \subseteq D_0^m$  we have that  $E_0^{m+1} \subseteq C_0^{m+1} \cup C_1^{m+1}$ . So using the claim we obtain that  $(A, B)$  is  $(m+2)$ -separated in  $\mathcal{K}$  by the sets  $C_0^{m+2}, C_1^{m+2}, \dots, C_{m+2}^{m+2}$ .  $\square$

Theorem 5.15 is a remarkable result. Literally taken it seems to pose that an equality (“ $m$ -separability equals  $m+1$ -separability”) translates upwards (“ $m$ -separability equals  $n$ -separability for all  $n \geq m$ ”). Actually we have a downward translation of equality. If we consider the corresponding partition classes  $\mathcal{K}(\mathfrak{S}_m)$ , then it clearly holds

- $\mathcal{K}(\mathfrak{S}_0) \supseteq \mathcal{K}(\mathfrak{S}_1) \supseteq \dots$ ,
- $\mathcal{K}(\mathfrak{S}_m) = \mathcal{K}(\mathfrak{S}_{m+1})$  implies for all  $n \geq m$ ,  $\mathcal{K}(\mathfrak{S}_m) = \mathcal{K}(\mathfrak{S}_n)$ .

Thus, in the refined boolean hierarchy of  $k$ -partition for  $k \geq 3$  we can observe downward collapses that are usually very rare to find in hierarchies (see discussions in, e.g., [All91, AW90, HJ95, HHH99]; the latter is based on Kadin’s downward translation with polynomial advice via the easy-hard technique we applied in Subsection 3.5.2).

It arises the issue of how far-reaching the collapse is. More specifically, when do

- $\mathcal{K}(\mathfrak{S}_m) = \mathcal{K}(\mathfrak{S}_{m+1}) \implies \mathcal{K}(\mathfrak{S}_m) = \mathcal{K}(\mathfrak{S}_\infty)$  or
- $\bigcap_{m=0}^{\infty} \mathcal{K}(\mathfrak{S}_m) = \mathcal{K}(\mathfrak{S}_\infty)$

hold? The validity of the second statement trivially implies the validity of the first statement. That the issue is reasonable follows from the next theorem.

**Theorem 5.16.**

1.  $\mathfrak{S}_\infty$  is the greatest 4-poset which is less than  $\mathfrak{S}_m$  for all  $m \in \mathbb{N}$ .
2.  $\mathfrak{S}_\infty^0$  is the greatest 3-poset which is less than  $\mathfrak{S}_m^0$  for all  $m \in \mathbb{N}$ .

*Proof.* We start with the proof of the second statement.

2. Obviously,  $\mathfrak{S}_\infty^0 \leq \mathfrak{S}_m^0$  for all  $m \geq 0$ . So it remains to prove that for all minimal 3-posets  $\mathfrak{T} = (T, t)$  with  $\mathfrak{T} \leq \mathfrak{S}_m^0$  for all  $m \geq 0$ , it holds that  $\mathfrak{T} \leq \mathfrak{S}_\infty^0$ . To do that we adapt some notions from graph theory. For any poset  $G$  we say that a subset  $E \subseteq G$  is isolated in  $G$  if for all  $x, y \in G$ ,  $x \leq y$  implies that  $x, y \in E$  or  $x, y \in G \setminus E$ . We say that a poset  $G$  is connected if  $G$  does not contain any isolated subset. Note that each poset  $G$  can be uniquely partitioned into maximal connected subposets. Let  $\mathfrak{T}' = (T', t')$  be any  $k$ -subposet of  $\mathfrak{T}$  such that  $T'$  is a maximal connected subposet of  $T$  and  $t'$  is the restriction of the labeling function  $t$  to  $T'$ . Note that  $\mathfrak{T}'$  is minimal since  $\mathfrak{T}$  is minimal. Then clearly,  $\mathfrak{T}' \leq \mathfrak{S}_m^0$  for all  $m \in \mathbb{N}$ . Let  $\varphi_m : T' \rightarrow S_m$  be a monotonic function witnessing  $\mathfrak{T}' \leq \mathfrak{S}_m^0$ . Since  $T'$  is connected,  $\varphi_m(T')$  is a connected subposet of  $S_m$ . Hence, for  $m > \|T'\|$  there exist no  $x, y \in \varphi_m(T')$  with  $s_m(x) = 1$  and  $s_m(y) = 2$ . Thus  $\|t'(T')\| \leq 2$ . Since  $T'$  is connected,  $\mathfrak{T}'$  has to be a labeled chain. Hence, represented as 3-words,  $\mathfrak{T}'$  is in  $\{1, 2, 3, 13, 23\}$ . Consequently,  $\mathfrak{T}' \leq \mathfrak{S}_\infty^0$ . Since  $T'$  was arbitrarily chosen among all maximal connected subposets of  $T$ , we obtain  $\mathfrak{T} \leq \mathfrak{S}_m^0$ .
1. Again it is obvious, that  $\mathfrak{S}_\infty \leq \mathfrak{S}_m$  for all  $m \geq 0$ . If, for any 4-poset  $\mathfrak{T} = (T, t)$ ,  $\mathfrak{T} \leq \mathfrak{S}_m$  for all  $m \in \mathbb{N}$ , then we consider the 4-poset  $\mathfrak{R} = (R, t)$  instead of  $\mathfrak{T}$  where  $R = T \setminus \{a \in T \mid (\exists b \in T)[t(b) = 4 \wedge a \leq b]\}$  and proceed as above. This is correct since each element in  $T$  which is labeled by 4 has to be mapped to the least element in  $\mathfrak{S}_m$ .  $\square$

From this theorem we easily obtain that between  $\mathfrak{S}_0$  and  $\mathfrak{S}_\infty$  no further (minimal) labeled posets can occur since all posets must exactly have the maximal chains 413 and 423 represented as 4-words. But  $\mathfrak{S}_m$  for  $m \in \mathbb{N} \cup \{\infty\}$  are all minimal labeled posets with this property. The same holds for the posets between  $\mathfrak{S}_0^0$  and  $\mathfrak{S}_\infty^0$ .

Finally, we apply all our notions and results to the class NP obtaining a probably infinite separation hierarchy.

**Theorem 5.17.** *Let  $m \in \mathbb{N}$ .*

1. *All pairs of NP sets are  $(m + 1)$ -separable in NP if and only if  $\text{NP} = \text{coNP}$ .*
2. *There exists a relativized world such that there is a pair of disjoint NP sets that is  $m$ -separable in NP but not  $(m + 1)$ -separable in NP.*

## 5.2 Fine Hierarchies inside $\text{BH}_2(\text{NP})$

The approach to investigate partition classes generated by  $k$ -posets leads in the case that  $k = 2$  to a much shrewder structuring of the boolean hierarchy of NP sets. For instance, consider the following well-known inclusion chain of the lowest non-trivial levels of the boolean hierarchy  $\text{BH}_2(\text{NP})$

$$\text{NP} \cup \text{coNP} \subseteq \text{P}_{\parallel}^{\text{NP}}[1] \stackrel{*}{\subseteq} \text{NP}(2) \cap \text{coNP}(2) \subseteq \text{NP}(2) \cup \text{coNP}(2) \subseteq \text{P}_{\parallel}^{\text{NP}}[2].$$

For each of the inclusions except the one marked by  $*$  it holds that the inclusion is strict unless the polynomial-time hierarchy collapses. More specifically, it holds that

1.  $\text{NP} \cup \text{coNP} = \text{P}_{\parallel}^{\text{NP}}[1]$  implies  $\text{NP} = \text{coNP}$ ,
2.  $\text{NP}(2) \cap \text{coNP}(2) = \text{NP}(2) \cup \text{coNP}(2)$  implies  $\text{NP}(2) = \text{coNP}(2)$ ,

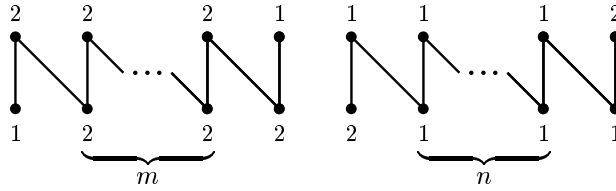

Fig. 5.4. The 2-poset  $\mathfrak{F}(m, n)$

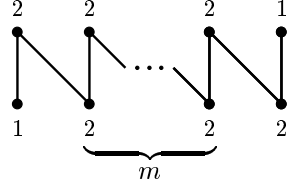

Fig. 5.5. The 2-poset  $\mathfrak{F}(m, \infty)$

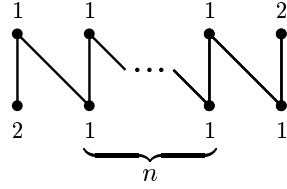

Fig. 5.6. The 2-poset  $\mathfrak{F}(\infty, n)$

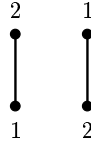

Fig. 5.7. The 2-poset  $\mathfrak{F}(\infty, \infty)$

3.  $\text{NP}(2) \cup \text{coNP}(2) = \text{P}_{\parallel}^{\text{NP}}[2]$  implies  $\text{NP}(2) = \text{coNP}(2)$ .

The second statement is obvious. The first statement and third statement are easily seen since for each  $r \in \mathbb{N}$  the class  $\text{P}_{\parallel}^{\text{NP}}[r]$  has a  $\leq_m^p$ -complete problem.

Only for the inclusion  $*$  it is not known whether equality collapses the polynomial-time hierarchy. The difference between these two classes seems apparently too fine to exploit them regarding such collapse consequences. However, the difference is large enough to contain probably infinite subhierarchies.

The following theorem is easy to conclude using the results we obtained in Chapter 4. Note that  $\text{P}_{\parallel}^{\text{NP}}[1] = \text{P} \oplus \text{NP}$  [Wag98] and that  $\mathfrak{F}(\infty, \infty) = \mathfrak{D}_2$  (see Figure 4.2).

**Theorem 5.18.** *Let  $m, n \in \mathbb{N} \cup \{\infty\}$  and let  $\mathfrak{F}(m, n)$  be the 2-posets presented in Figures 5.4-5.7.*

1.  $\text{NP}(\mathfrak{F}(0, 0)) \subseteq \text{NP}(\mathfrak{H}_2) = \text{NP}(2) \cap \text{coNP}(2)$ .
2.  $\text{NP}^C(\mathfrak{F}(m, n)) \subseteq \text{NP}^C(\mathfrak{F}(m', n'))$  for all oracles  $C$  if and only if  $m \leq m'$  and  $n \leq n'$ .
3.  $\text{P}_{\parallel}^{\text{NP}}[1] \subseteq \text{NP}(\mathfrak{F}(\infty, \infty)) = (\text{NP} \cap \text{coNP}) \oplus \text{NP}$ .

The class  $(\text{NP} \cap \text{coNP}) \oplus \text{NP}$  is astonishingly robust in a sense that it has many different characterizations (see [Wag98, HHH98a]). It can be considered as:

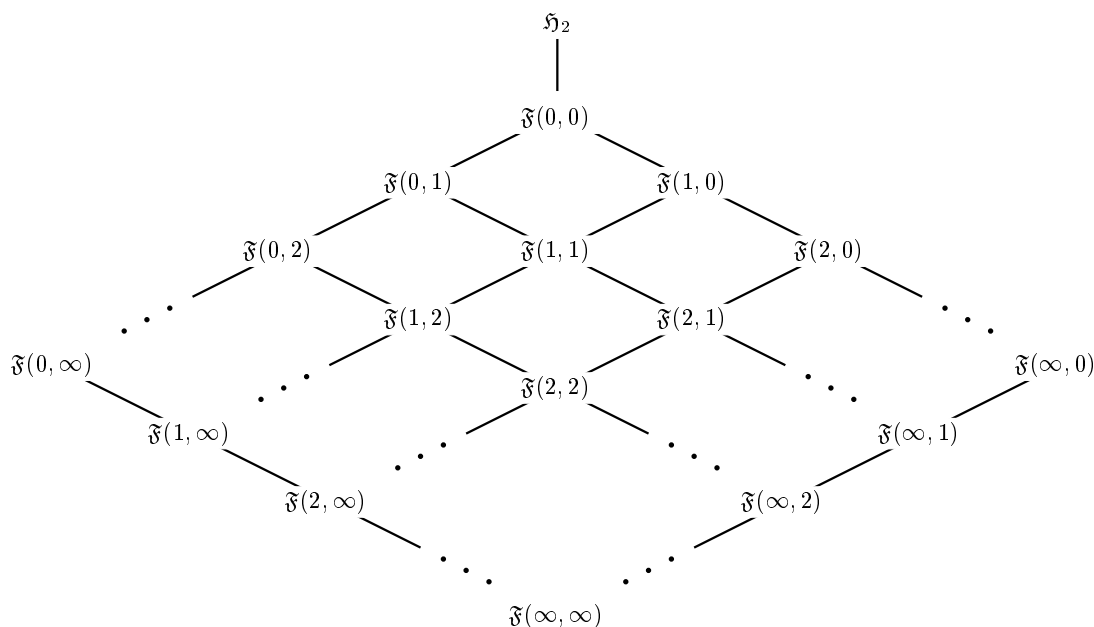

**Fig. 5.8.** The 2-posets generating classes between  $(\text{NP} \cap \text{coNP}) \oplus \text{NP}$  and  $\text{NP}(2) \cap \text{coNP}(2)$

1. The class generated by  $\mathfrak{D}_2 = \mathfrak{F}(\infty, \infty)$  over NP.
2. The class of all sets that are 1-truth-table strong nondeterministic reducible to some NP set.
3. The class of all sets that can be decided by deterministic polynomial-time machine making one query to an oracle from  $\text{NP} \cap \text{coNP}$  followed by one query to some NP set (and the other way round).
4. The class of all sets that can be decided by deterministic polynomial-time machine making, simultaneously, one query to an oracle from  $\text{NP} \cap \text{coNP}$  and one query to some NP.

Figure 5.8 shows the structure of all complexity classes generated by posets between  $\text{P}_{\parallel}^{\text{NP}}[1]$  and  $\text{NP}(2) \cap \text{coNP}(2)$ . Each of the classes described by their defining posets is different to another class in at least one relativized world.

Similar and still more complicated subhierarchies as those we considered here can be observed in higher levels of the boolean hierarchy of sets over NP.

### 5.3 Reducing the Set of Solutions of NP Problems

When facing with concrete computational problems it is often not enough to know that a solution to a given instance of the problem exists but one wishes to find one. For instance, considering a propositional formula we are not content with knowing that a truth assignment exists that makes the formula satisfied. We would like to have a witness to that. Thus computational problems can be regarded as set functions, mapping from a problem instance to the set of all solutions. The set of solutions may be empty, may have only one solution, or may have exponentially many solutions (when considering NP problems). For that reason



we refer to such  $f$  functions as possibly partial, possibly multi-valued functions. We say that  $f(x)$  is not defined if and only if  $f(x) = \emptyset$ .

The basic class NPMV introduced by Book, Long, and Selman [BLS84] contains all set functions that correspond to NP decision problems. More specifically, NPMV consists of all possibly partial, possibly multi-valued functions  $f$  for which there exists a nondeterministic polynomial-time Turing transducer such that  $f(x)$  is exactly the set of all outputs (“solutions”) made by the transducer on  $x$  on accepting paths. This and similar classes of polynomial-time computable partial, multi-valued functions have attracted much attention in several complexity-theoretic settings (see, e.g., [GS88, FFNR96, FHOS97, FGH<sup>+</sup>99, JT97, Sel92, Sel94b, Sel96]). Most of the work addresses questions about NP search problems, inverting polynomial-time computable functions, and more fundamentally, the power of nondeterminism (for a discussion see the survey papers [Sel94b, JT97]).

The natural notion to compare computational problems that are formalized as partial, multi-valued functions is the refinement [BLS84]. We say that a function  $f$  is a refinement of the function  $f'$  if and only if  $D_f = D_{f'}$  and for all  $x$ ,  $f(x) \subseteq f'(x)$ . Let  $\mathcal{F}$  and  $\mathcal{F}'$  be classes of partial multi-valued functions. The fact that a function  $f$  has a refinement in  $\mathcal{F}$  is denoted by  $f \in_c \mathcal{F}$ . We write  $\mathcal{F} \subseteq_c \mathcal{F}'$  if and only if for all  $f \in \mathcal{F}$ ,  $f \in_c \mathcal{F}'$ .

If we consider partial multi-valued functions as mappings that assign to each problem instance a set of solutions to the instance then the vital point in the definition of refinements is the diminishment of solution sets. For instance, one could ask whether it is possible to find for each function in NPMV a refinement in the class of all partial functions computable in deterministic polynomial time. That means is it possible to select among all possibly exponentially many outputs of nondeterministic transducer one output in polynomial-time. This question is equivalent to  $P = NP$  [Sel92].

A very similar question (raised by Selman [Sel94b]) has been investigated by Hemaspaandra *et al.* [HNOS96] who have asked whether every function in NPMV has a refinement in NPSV where NPSV is the class of single-valued functions in NPMV, i.e., the class of all NPMV functions  $f$  such that  $\|f(x)\| \leq 1$  for all  $x$ . They showed that this is true only if the polynomial hierarchy collapses to its second level (even down to the class  $ZPP^{NP}$ ). In fact, they proved that some two-valued NPMV functions have no refinement in NPSV unless the polynomial hierarchy collapses to  $\Sigma_2^p$ . Building on results like these, Ogihara [Ogi96] showed that for all  $m \in \mathbb{N}$ , some NPMV function have no refinements  $g$  in NPMV with  $\|g(x)\| \leq |x|^m$  for all  $x$ , unless  $PH = \Sigma_2^p$ , and Naik *et al.* [NRRS98] showed that for all  $m > 2$ , some  $m$ -valued functions in NPMV have no  $(m - 1)$ -valued refinement in NPMV, unless  $PH = \Sigma_2^p$ .

All the results suggest that the output cardinality is a computing resource that strongly influences the computing power of NP machines. Hemaspaandra, Ogihara, and Wechsung [HOW00] brought the issue to its ultimate shape. For any  $A \subseteq \mathbb{N}_+$ , let  $NP_AV$  denote the class of all NPMV functions  $f$  satisfying for all  $x \in \Sigma^*$  that the number of solutions of  $f(x)$  is an element of  $\{0\} \cup A$ . The challenge now is to “completely characterize, perhaps under some complexity-theoretic assumption, the sets  $A \subseteq \mathbb{N}_+$ , and  $B \subseteq \mathbb{N}_+$  such that  $NP_AV \subseteq NP_BV$ ” [HOW00].

We focus on the problem of determining for which finite sets  $A \subseteq \mathbb{N}_+$  and  $B \subseteq \mathbb{N}_+$  it holds  $NP_AV \subseteq_c NP_BV$ . To cope this challenge, the following property has been detected as a promising one.



**Fig. 5.9.** The 5-posets  $\mathfrak{N}(\{1, 3\})$  (on the left) and  $\mathfrak{N}(\{1, 3\}, \{1, 2\})$  (on the right)

**Definition 5.19.** [HOW00] Let  $A, B \subseteq \mathbb{N}_+$  be finite,  $A = \{a_1, a_2, \dots, a_m\}$  with  $a_1 < a_2 < \dots < a_m$ . We say that the pair  $(A, B)$  satisfies the *narrowing-gap condition* if and only if  $\|A\| = 0$  or there exist  $b_1, b_2, \dots, b_m \in B$  such that  $a_1 - b_1 \geq a_2 - b_2 \geq \dots \geq a_m - b_m \geq 0$ .

**Theorem 5.20.** [HOW00] Let  $A, B \subseteq \mathbb{N}_+$  be finite. If  $(A, B)$  satisfies the narrowing-gap condition, then  $\text{NP}_A \text{V} \subseteq_c \text{NP}_B \text{V}$ .

According to the results we mentioned above it has been conjectured that the narrowing-gap condition is not only sufficient but in fact necessary unless the polynomial hierarchy collapses. The Narrowing-Gap Conjecture states that for each pair of finite sets  $A \subseteq \mathbb{N}_+$  and  $B \subseteq \mathbb{N}_+$  that do not satisfy the narrowing-gap condition, we have that  $\text{NP}_A \text{V} \subseteq_c \text{NP}_B \text{V}$  implies  $\text{PH} = \Sigma_2^p$ . This conjecture has been supported in very sophisticated ways. However, the theorems proven in [HOW00] which cover all previously known results do not fully match the narrowing-gap condition.

Adopting that in  $\text{RBH}_k(\text{NP})$  no further inclusions of partition classes hold than those induced by the relation  $\leq$ , i.e.,  $\text{NP}(G, f) \not\subseteq \text{NP}(G', f')$  whenever  $(G, f) \not\leq (G', f')$ , we prove that in fact, the narrowing-gap condition is necessary for refinements. To do that, we define particular posets representing a pair of finite sets. Note that if  $\min A < \min B$  then  $\text{NP}_A \text{V} \not\subseteq_c \text{NP}_B \text{V}$  unrelativized (and in all relativizations).

**Definition 5.21.** Let  $A, B \subseteq \mathbb{N}_+$  be finite with  $\min B \leq \min A = m$ .

1.  $\mathfrak{N}(A)$  denotes the finite labeled poset  $((G, \leq), f)$  with
  - $G = \{x \in \{1, 2\}^m \mid |x|_1 \in \{0\} \cup A\}$ ,
  - $f(x) = \|\{z \in G \mid x \leq_{\text{lex}} z\}\|$  for all  $x \in G$ .
2.  $\mathfrak{N}(A, B)$  denotes the finite labeled poset  $((G, \leq), f)$  with
  - $G = \{(x, y) \mid x, y \in \{1, 2\}^m, |x|_1 \in A, |y|_1 \in B, x \leq y\} \cup \{(2^m, 2^m)\}$ ,
  - $f(x, y) = \|\{z \mid x \leq_{\text{lex}} z \wedge (\exists t)[(z, t) \in G]\}\|$  for all  $(x, y) \in G$ .

In Figure 5.9, posets representing the question of whether  $\text{NP}_{\{1,3\}} \text{V} \subseteq_c \text{NP}_{\{1,2\}} \text{V}$  (which is known to imply a collapse of the polynomial hierarchy) are drawn. Observe that  $\mathfrak{N}(\{1, 3\}) \not\leq \mathfrak{N}(\{1, 3\}, \{1, 2\})$ .

**Theorem 5.22.** Let  $A, B \subseteq \mathbb{N}_+$  be finite with  $\min B \leq \min A$ . Then the following statements are equivalent.

1.  $\text{NP}_A \text{V}^C \subseteq_c \text{NP}_B \text{V}^C$  for all oracles  $C$ .
2.  $\text{NP}^C(\mathfrak{N}(A)) \subseteq \text{NP}^C(\mathfrak{N}(A, B))$  for all oracles  $C$ .
3.  $\mathfrak{N}(A) \leq \mathfrak{N}(A, B)$ .
4.  $(A, B)$  satisfies the narrowing-gap condition.

*Proof.*

- (1)  $\Rightarrow$  (2): Note that the proof we present relativizes. Let  $(G, f) = \mathfrak{N}(A)$  and  $(G', f') = \mathfrak{N}(A, B)$ . Let  $(G, f, S) \in \text{NP}(G, f)$ . Define a multi-valued function  $\varphi$  as

$$\varphi(x) =_{\text{def}} \{ i \mid \text{there is a } w \in G \text{ with } w_i = 1 \text{ and } x \in S(w) \}$$

for all  $x \in \Sigma^*$ . We have to show that  $\varphi \in \text{NP}_{AV}$ .

1.  $\varphi \in \text{NPMV}$ : Since  $S$  is an NP-homomorphism on a finite poset  $G$  there is for each  $w \in G$  a nondeterministic polynomial-time Turing machine  $M_w$  accepting  $S(w)$ . Define  $M$  to be a transducer that on input  $x$ , (a) guesses nondeterministically a  $w \in G$ , (b) simulates  $M_w$  on  $x$ , and (c) if simulation accepts along a computation path, then outputs all  $i$  with  $w_i = 1$  on different accepting path prolongations.  $M$  runs in polynomial time and the set of outputs of  $M(x)$  along accepting paths is just  $\varphi(x)$ .
2.  $\|\varphi(x)\| \in \{0\} \cup A$  for all  $x \in \Sigma^*$ : Let  $x \in \Sigma^*$ . There exists exactly one  $w \in G$  with  $x \in T_S(w)$ . Further let  $R_w$  denote the set  $\{i \mid w_i = 1\}$ . Obviously,  $R_w \subseteq \varphi(x)$ . It suffices to show  $\varphi(x) = R_w$ . Assume  $R_w \neq \varphi(x)$ , i.e., there is a  $j \in \varphi(x)$  which is not in  $R_w$ . Thus there is a  $v \in G$  with  $v \not\leq w$ ,  $v_j = 1$ , and  $x \in S(v)$ . Hence,  $x \in S(v) \cap S(w) = \bigcup_{z < w, z \leq v} S(z)$ . So there must exist a  $z \in G$  with  $z < w$ ,  $z_i = 1$ , and  $x \in S(z)$ . Consequently,  $x \notin T_S(w)$ , a contradiction.

From the assumption that  $\text{NP}_{AV} \subseteq_c \text{NP}_{BV}$  we get a multi-valued function  $\varphi' \in \text{NP}_{BV}$  with  $D_\varphi = D_{\varphi'}$  and  $\varphi'(x) \subseteq \varphi(x)$  for all  $x \in \Sigma^*$ . Consider the following mapping  $T$  for all  $b \in \{1, 2\}^m$  given as

$$T(b) = \{ x \mid \{i \mid b_i = 1\} \subseteq \varphi'(x) \}.$$

Clearly,  $T(b) \in \text{NP}$  and  $T(b) \cap T(c) = T(b \wedge c)$ .

Define a mapping  $S' : G' \rightarrow \text{NP}$  for all  $(a, b) \in G'$  by

$$S'(a, b) =_{\text{def}} S(a) \cap T(b).$$

We will show that  $S'$  is an NP-homomorphism on  $G'$  with  $(G', f', S') = (G, f, S)$ , that is

1.  $\bigcup_{(a,b) \in G'} S'(a, b) = \Sigma^*$ ,
2.  $S'(a, b) \cap S'(a', b') = \bigcup_{(c,d) \in G', (c,d) \leq (a,b), (a',b')} S'(c, d)$  for all  $(a, b), (a', b') \in G'$ ,
3.  $T_{S'}(a, b) \subseteq T_S(a)$  for all  $(a, b) \in G'$ .

This can be seen as follows.

1. Observe that  $G'$  has the supremum  $(2^m, 2^m)$  for which  $S'(2^m, 2^m) = \Sigma^*$ .
2. The inclusion “ $\supseteq$ ” holds because  $S'$  is monotonic. For “ $\subseteq$ ” let  $x \in S'(a, b) \cap S'(a', b') = S(a) \cap S(a') \cap T(b \wedge b')$ . Since  $S$  is an NP-homomorphism on  $G$  and  $a, a' \in G$ , there are  $c \in G$  with  $c \leq a$ ,  $c \leq a'$ , and  $x \in S(c)$ , among them the word  $c$  with  $x \in T_S(c)$ . Considering this word we obtain  $x \in S(c) \cap T(b \wedge b')$  and  $\{i \mid c_i = 1\} = \varphi(x)$  by construction of  $\varphi$ . Let  $c'$  be the word in  $\{1, 2\}^m$  satisfying  $\{i \mid c'_i = 1\} = \varphi'(x)$ . Thus  $|c'|_1 \in \{0\} \cup B$ . Since  $x \in T(b \wedge b')$ , i.e.,  $\{i \mid (b \wedge b')_i = 1\} \subseteq \varphi'(x)$ , we get  $c' \leq b \wedge b'$ . Moreover,  $\varphi'(x) \subseteq \varphi(x)$  implies  $c \leq c'$ . Hence,  $(c, c') \in G'$ ,  $(c, c') \leq (a, b)$ ,  $(c, c') \leq (a', b')$ , and  $x \in S(c) \cap T(c') = S'(c, c')$ .
3. The case  $(a, b) = (2^m, 2^m)$  is trivial. So let  $a \neq 2^m$  and  $b \neq 2^m$ . Let  $x \in T_{S'}(a, b)$ . Then  $x \in S'(a, b) = S(a) \cap T(b) \subseteq S(a)$ . Assume  $x \notin T_S(a)$ . Then there is a  $c < a$

with  $x \in S(c)$ , say that  $c$  with  $x \in T_S(c)$ . Thus  $\{i \mid c_i = 1\} = \varphi(x)$ . Since  $D_\varphi = D_{\varphi'}$  and  $\{i \mid b_i = 1\} \subseteq \varphi'(x) \subseteq \varphi(x)$  there is a  $d \leq b$  with  $c \leq d$ ,  $|d|_1 \in B$ , and  $x \in T(d)$ . Hence,  $(c, d) < (a, b)$ ,  $(c, d) \in G'$  and  $x \in S(c) \cap T(d) = S'(c, d)$ . Thus,  $x \notin T_{S'}(a, b)$  what is a contradiction.

- (2)  $\Rightarrow$  (3) is immediately given by Theorem 4.42.
- (3)  $\Rightarrow$  (4): Let  $(G, f) = \mathfrak{N}(A)$  and  $(G', f') = \mathfrak{N}(A, B)$ . Let  $\varphi : G \rightarrow G'$  be a monotonic mapping which witnesses  $(G, f) \leq (G', f')$ . Let  $\varphi_A(w)$  denote the first component of  $\varphi(w)$  and  $\varphi_B(w)$  denote the second component of  $\varphi(w)$ , i.e.,  $\varphi(w) = (\varphi_A(w), \varphi_B(w))$ . Since  $f$  is injective we have that  $\varphi$  is injective. Thus, it holds  $\varphi_A(w) = w$  and  $w \leq \varphi_B(w)$  for all  $w \in G$ . The latter implies  $|w|_1 \geq |\varphi_B(w)|_1$ . Let  $A = \{a_1, \dots, a_m\}$  with  $a_1 < \dots < a_m$ . We will find a sequence  $b_1, \dots, b_m \in B$  with  $a_1 - b_1 \geq \dots \geq a_m - b_m \geq 0$ . For that, consider sets  $G_j = \{w \in G \mid |w|_1 = a_j\}$ . Assume for the moment the claim below would already be proven. If we iterate this claim we get a sequence  $1^{a_m}, w_{m-1}, \dots, w_1$  with

$$a_1 - |\varphi_B(w_1)|_1 \geq \dots \geq a_{m-1} - |\varphi_B(w_{m-1})|_1 \geq a_m - |\varphi_B(1^{a_m})|_1 \geq 0.$$

Hence, setting  $b_j = |\varphi_B(w_j)|_1$  proves that  $(A, B)$  satisfies the narrowing-gap condition. So it remains to show the following claim:

**Claim.** *Let  $w \in G_j$  for  $j \geq 2$ . There exists a  $v \in G_{j-1}$  with  $v > w$  and  $a_{j-1} - |\varphi_B(v)|_1 \geq a_j - |\varphi_B(w)|_1$ .*

To prove it, without loss of generality, let  $w$  have the prefix consisting of  $a_j$  times the letter 1 and, for convenience, let  $\varphi_B(w)$  have the prefix consisting of  $|\varphi_B(w)|_1$  times the letter 1. Assume to the contrary that for all  $v \in G_{j-1}$  with  $v > w$  it holds  $a_{j-1} - |\varphi_B(v)|_1 < a_j - |\varphi_B(w)|_1$ . Let  $b_j = |\varphi_B(w)|_1$  and  $b_{j-1} = \min\{|\varphi_B(v)|_1 \mid v \in G_{j-1}, v > w\}$ . The assumption implies  $b_j - b_{j-1} < a_j - a_{j-1}$ . Consider the word  $v'$  having the prefix starting with  $a_j - a_{j-1}$  times the letter 2 and then having  $a_{j-1}$  times the letter 1 before coming 2's again. Clearly,  $v' > w$  and  $v' \in G_{j-1}$ . Since  $\varphi$  is monotonic, we have (a)  $\varphi_B(v') \geq \varphi_B(w)$  and (b)  $\varphi_B(v') \geq v'$ . From (b) it follows that  $\varphi_B(v')$  must start with at least  $a_j - a_{j-1}$  times the letter 2 and from (a) it follows that  $\varphi_B(v')$  can have at most  $b_j - b_{j-1}$  times the letter 2 in any prefix before coming a letter 1. Hence,  $\varphi_B(v') \not\geq v'$ , a contradiction.

- Relativizing Theorem 5.20 shows (4)  $\Rightarrow$  (1). □

**Corollary 5.23.** *Assume that in  $\text{RBH}_k(\text{NP})$  no further inclusions hold than those induced by the relation  $\leq$  on  $k$ -posets. Let  $A, B \subseteq \mathbb{N}_+$  be finite. Then  $(A, B)$  satisfies the narrowing-gap condition if and only if  $\text{NP}_A V \subseteq_c \text{NP}_B V$ .*

*Proof.* The direction  $(\Rightarrow)$  follows from Theorem 5.20. For  $(\Leftarrow)$  suppose that  $(A, B)$  does not satisfy the narrowing-gap condition. By contraposition of implication (3)  $\Rightarrow$  (4) in Theorem 5.22 we obtain  $\mathfrak{N}(A) \not\leq \mathfrak{N}(A, B)$ . By supposition we have  $\text{NP}(\mathfrak{N}(A)) \not\subseteq_c \text{NP}(\mathfrak{N}(A, B))$ . Thus the contraposition of implication (1)  $\Rightarrow$  (2) in Theorem 5.22 (observe from the proof that the implication holds relative to the same oracle) shows  $\text{NP}_A V \not\subseteq_c \text{NP}_B V$ . □

**Corollary 5.24.** *Let  $A, B \subseteq \mathbb{N}_+$  be finite. Then  $(A, B)$  satisfies the narrowing-gap condition if and only if  $\text{NP}_A V^D \subseteq_c \text{NP}_B V^D$  for all oracles  $D$ .*

## Bibliography

- [ABO99] E. Allender, R. Beals, and M. Ogiwara. The complexity of matrix rank and feasible systems of linear equations. *Computational Complexity*, 8:99–126, 1999.
- [All91] E. Allender. Limitations of the upward separation technique. *Mathematical Systems Theory*, 24:53–67, 1991.
- [AW90] E. Allender and C. Wilson. Downward translations of equality. *Theoretical Computer Science*, 75:335–346, 1990.
- [BBJ<sup>+</sup>89] A. Bertoni, D. Bruschi, D. Joseph, M. Sitharam, and P. Young. Generalized boolean hierarchies and boolean hierarchies over RP. In *Proceedings 7th International Conference on Fundamentals in Computation Theory*, volume 380 of *Lecture Notes in Computer Science*, pages 35–46. Springer-Verlag, Berlin, 1989.
- [BCO93] R. Beigel, R. Chang, and M. Ogiwara. A relationship between difference hierarchies and relativized polynomial hierarchies. *Mathematical Systems Theory*, 26(3):293–310, 1993.
- [BCS92] D. P. Bovet, P. Crescenzi, and R. Silvestri. A uniform approach to define complexity classes. *Theoretical Computer Science*, 104:263–283, 1992.
- [BDG90] J. L. Balcázar, J. Díaz, and J. Gabarró. *Structural Complexity II*, volume 22 of *EATCS Monographs on Theoretical Computer Science*. Springer-Verlag, Berlin, 1990.
- [BDG95] J. L. Balcázar, J. Díaz, and J. Gabarró. *Structural Complexity I*. Texts in Theoretical Computer Science. An EATCS Series. Springer-Verlag, Berlin, 2nd edition, 1995.
- [Bei88] R. Beigel. NP-hard sets are P-superterse unless  $R=NP$ . Technical Report TR 88-04, Johns Hopkins University, Baltimore, 1988.
- [Bei91] R. Beigel. Bounded queries to SAT and the boolean hierarchy. *Theoretical Computer Science*, 84(2):199–223, 1991.
- [Bel77] N. D. Belnap. How a computer should think. In G. Ryle, editor, *Contemporary Aspects of Philosophy*, pages 30–55. Oriel Press, 1977.
- [BI87] M. Blum and R. Impagliazzo. Generic oracles and oracle classes. In *Proceedings 28th Symposium on Foundations of Computer Science*, pages 118–126. IEEE Computer Society Press, Los Alamitos, 1987.
- [BJY90] D. Bruschi, D. Joseph, and P. Young. Strong separations for the boolean hierarchy over RP. *International Journal of Foundations of Computer Science*, 1(3):201–217, 1990.
- [BKS99] B. Borchert, D. Kuske, and F. Stephan. On existentially first-order definable languages and their relation to NP. *RAIRO Theoretical Informatics and Applications*, 33(3):257–270, 1999.

- [BLS84] R. V. Book, T. J. Long, and A. L. Selman. Quantitative relativizations of complexity classes. *SIAM Journal on Computing*, 13:461–487, 1984.
- [Cai87] J.-Y. Cai. Probability one separation of the boolean hierarchy. In *Proceedings 4th Symposium on Theoretical Aspects of Computer Science*, volume 38 of *Lecture Notes in Computer Science*, pages 148–158. Springer-Verlag, Berlin, 1987.
- [CGH<sup>+</sup>88] J.-Y. Cai, T. Gundermann, J. Hartmanis, L. A. Hemachandra, V. Sewelson, K. W. Wagner, and G. Wechsung. The boolean hierarchy I: Structural properties. *SIAM Journal on Computing*, 17(6):1232–1252, 1988.
- [CGH<sup>+</sup>89] J.-Y. Cai, T. Gundermann, J. Hartmanis, L. A. Hemachandra, V. Sewelson, K. W. Wagner, and G. Wechsung. The boolean hierarchy I: Applications. *SIAM Journal on Computing*, 18:95–111, 1989.
- [CH86] J.-Y. Cai and L. Hemachandra. The Boolean hierarchy: Hardware over NP. In *Proceedings 1st Structure in Complexity Theory Conference*, volume 223 of *Lecture Notes in Computer Science*, pages 105–124. Springer-Verlag, Berlin, 1986.
- [CHVW98] K. Cronauer, U. Hertrampf, H. Vollmer, and K. W. Wagner. The chain method to separate counting classes. *Theory of Computing Systems*, 31(1):93–108, 1998.
- [DP90] B. A. Davey and H. A. Priestley. *Introduction to Lattices and Order*. Cambridge University Press, Cambridge, 1990.
- [Ers68a] Y. L. Ershov. A hierarchy of sets I. *Algebra i Logika*, 7(1):47–74, 1968. In Russian.
- [Ers68b] Y. L. Ershov. A hierarchy of sets II. *Algebra i Logika*, 7(4):15–47, 1968. In Russian.
- [FFNR96] S. Fenner, L. Fortnow, A. V. Naik, and J. D. Rogers. Inverting onto functions. In *Proceedings 11th IEEE Conference on Computational Complexity*, pages 213–222. IEEE Computer Society Press, Los Alamitos, 1996.
- [FGH<sup>+</sup>99] S. Fenner, F. Green, S. Homer, A. L. Selman, T. Thierauf, and H. Vollmer. Complements of multivalued functions. *Chicago Journal of Theoretical Computer Science*, 1999(3), 1999.
- [FHOS97] S. Fenner, S. Homer, M. Ogihara, and A. L. Selman. On using oracles that compute values. *SIAM Journal on Computing*, 26(4):1043–1065, 1997.
- [FHT97] S. Fischer, L. A. Hemaspaandra, and L. Torenvliet. Witness-isomorphic reductions and local search. In A. Sorbi, editor, *Complexity, Logic, and Recursion Theory*, volume 187 of *Lecture Notes in Pure and Applied Mathematics*, pages 207–223. Marcel Dekker, Inc., New York, 1997.
- [FR94] L. Fortnow and J. Rogers. Separability and one-way functions. In *Proceedings 5th International Symposium on Algorithms and Computation*, volume 834 of *Lecture Notes in Computer Science*, pages 396–404. Springer-Verlag, Berlin, 1994.
- [GJ79] M. R. Garey and D. S. Johnson. *Computers and Intractability: A Guide to the Theory of NP-Completeness*. W. H. Freeman and Company, New York, 1979.
- [GNW90] T. Gundermann, N. A. Nasser, and G. Wechsung. A survey on counting classes. In *Proceedings 5th Structure in Complexity Theory Conference*, pages 140–153. IEEE Computer Society Press, Los Alamitos, 1990.
- [Grä78] G. Grätzer. *General Lattice Theory*. Akademie-Verlag, Berlin, 1978.
- [GS88] J. Grollmann and A. L. Selman. Complexity measures for public-key cryptosystems. *SIAM Journal on Computing*, 17(2):309–335, 1988.

- [GS00] C. Glaßer and H. Schmitz. The boolean structure of dot-depth one. In *Proceedings 2nd International Workshop on Descriptive Complexity of Automata, Grammars, and Related Structures*, London, Ontario, 2000.
- [GW86] T. Gundermann and G. Wechsung. Nondeterministic Turing machines with modified acceptance. In *Proceedings 12th Symposium on Mathematical Foundations of Computer Science*, volume 233 of *Lecture Notes in Computer Science*, pages 396–404. Springer-Verlag, Berlin, 1986.
- [Hau14] F. Hausdorff. *Grundzüge der Mengenlehre*. Veit, Leipzig, 1914.
- [Her92a] U. Hertrampf. Locally definable acceptance types—the three-valued case. In *Proceedings 1st Latin American Symposium on Theoretical Informatics*, volume 583 of *Lecture Notes in Computer Science*, pages 262–271. Springer-Verlag, Berlin, 1992.
- [Her92b] U. Hertrampf. Locally definable acceptance types for polynomial time machines. In *Proceedings 9th Symposium on Theoretical Aspects of Computer Science*, volume 577 of *Lecture Notes in Computer Science*, pages 199–207. Springer-Verlag, Berlin, 1992.
- [Her95] U. Hertrampf. Classes of bounded counting type and their inclusion relations. In *Proceedings 12th Symposium on Theoretical Aspects of Computer Science*, volume 900 of *Lecture Notes in Computer Science*, pages 60–70. Springer-Verlag, Berlin, 1995.
- [HHH98a] E. Hemaspaandra, L. A. Hemaspaandra, and H. Hempel.  $R_{1-tt}^{SN}(\text{NP})$  distinguishes robust many-one and Turing-completeness. *Theory of Computing Systems*, 31:307–325, 1998.
- [HHH98b] E. Hemaspaandra, L. A. Hemaspaandra, and H. Hempel. What’s up with downward collapse: Using the easy-hard technique to link boolean and polynomial hierarchy collapses. *Complexity Theory Column 21, ACM-SIGACT Newsletter*, 29(3):10–22, 1998.
- [HHH99] E. Hemaspaandra, L. A. Hemaspaandra, and H. Hempel. A downward collapse within the polynomial hierarchy. *SIAM Journal on Computing*, 28(2):383–393, 1999.
- [HHN<sup>+</sup>95] L. A. Hemaspaandra, A. Hoene, A. V. Naik, M. Ogihara, A. L. Selman, T. Thierauf, and J. Wang. Nondeterministically selective sets. *International Journal of Foundations of Computer Science*, 6(4):403–416, 1995.
- [HJ95] L. A. Hemaspaandra and S. K. Jha. Defying upward and downward separation. *Information and Computation*, 121(1):1–13, 1995.
- [HNOS96] L. A. Hemaspaandra, A. V. Naik, M. Ogihara, and A. L. Selman. Computing solutions uniquely collapses the polynomial hierarchy. *SIAM Journal on Computing*, 25(4):697–708, 1996.
- [HOW00] L. A. Hemaspaandra, M. Ogihara, and G. Wechsung. Reducing the number of solutions of NP functions. In *Proceedings 25th Symposium on Mathematical Foundations of Computer Science*, volume 1893 of *Lecture Notes in Computer Science*, pages 394–404. Springer-Verlag, Berlin, 2000.
- [HR97] L. A. Hemaspaandra and J. Rothe. Unambiguous computation: Boolean hierarchies and sparse Turing-complete sets. *SIAM Journal on Computing*, 26(3):634–653, 1997.

- [JT97] B. Jenner and J. Torán. The complexity of obtaining solutions for problems in NP and NL. In L. A. Hemaspaandra and A. L. Selman, editors, *Complexity Theory Retrospective II*, pages 155–178. Springer-Verlag, New York, 1997.
- [Juc96] K. Jucht. Klassen von Dreier-Partitionen. Diplomarbeit, Julius-Maximilians-Universität Würzburg, Institut für Informatik, Würzburg, 1996.
- [Kad88] J. Kadin. The polynomial time hierarchy collapses if the Boolean hierarchy collapses. *SIAM Journal on Computing*, 17(6):1263–1282, 1988. Erratum in same journal 20(2):404, 1991.
- [Kec95] A. S. Kechris. *Classical Descriptive Set Theory*, volume 156 of *Graduate Texts in Mathematics*. Springer-Verlag, New York, 1995.
- [KL80] R. M. Karp and R. J. Lipton. Some connections between nonuniform and uniform complexity classes. In *Proceedings 12th ACM Symposium on Theory of Computing*, pages 302–309, 1980. An extended version appeared as: Turing machines that take advice, *L’Enseignement Mathématique*, 2nd series, 1982, pages 191–209.
- [Kle50] S. K. Kleene. A symmetric form of Gödel’s theorem. *Ind. Math.*, 12:244–246, 1950.
- [KM98] J. Köbler and J. Messner. Complete problems for promise classes by optimal proof systems for test sets. In *Proceedings 13th IEEE Conference on Computational Complexity*, pages 182–185. IEEE Computer Society Press, Los Alamitos, 1998.
- [Ko83] K. Ko. On self-reducibility and weak P-selectivity. *Journal of Computer and System Sciences*, 26:209–221, 1983.
- [Ko89] K. Ko. Relativized polynomial time hierarchies having exactly  $k$  levels. *SIAM Journal on Computing*, 18(2):392–408, 1989.
- [Kos00a] S. Kosub. Boolean partitions and projective closure. Technical Report 266, Julius-Maximilians-Universität Würzburg, Institut für Informatik, November 2000.
- [Kos00b] S. Kosub. On NP-partitions over posets with an application of reducing the set of solutions of NP problems. In *Proceedings 25th Symposium on Mathematical Foundations of Computer Science*, volume 1893 of *Lecture Notes in Computer Science*, pages 467–476. Springer-verlag, Berlin, 2000.
- [Kos00c] S. Kosub. On NP-partitions over posets with an application of reducing the set of solutions of NP problems. Technical Report 257, Julius-Maximilians-Universität Würzburg, Institut für Informatik, April 2000.
- [Kos00d] S. Kosub. Types of separability. Technical Report 267, Julius-Maximilians-Universität Würzburg, Institut für Informatik, November 2000.
- [KSV98] S. Kosub, H. Schmitz, and H. Vollmer. Uniformly defining complexity classes of functions. In *Proceedings 15th Symposium on Theoretical Aspects of Computer Science*, volume 1373 of *Lecture Notes in Computer Science*, pages 607–617. Springer-Verlag, Berlin, 1998. Journal version to appear in *International Journal of Foundations of Computer Science*.
- [KSW87] J. Köbler, U. Schöning, and K. W. Wagner. The difference and truth-table hierarchies for NP. *RAIRO Theoretical Informatics and Applications*, 21(4):419–435, 1987.



- [KW99] S. Kosub and K. W. Wagner. The boolean hierarchy of partitions. Technical Report 233, Julius-Maximilians-Universität Würzburg, Institut für Informatik, July 1999. Revised, November 2000.
- [KW00] S. Kosub and K. W. Wagner. The boolean hierarchy of NP-partitions. In *Proceedings 17th Symposium on Theoretical Aspects of Computer Science*, volume 1770 of *Lecture Notes in Computer Science*, pages 157–168. Springer-Verlag, Berlin, 2000.
- [LV97] M. Li and P. M. B. Vitányi. *An Introduction to Kolmogorov Complexity and Its Applications*. Graduate Texts in Computer Science. Springer-Verlag, New York, 2nd edition, 1997.
- [MS72] A. R. Meyer and L. J. Stockmeyer. The equivalence problem for regular expressions with squaring requires exponential time. In *Proceedings 13th Symposium on Switching and Automata Theory*, pages 125–129. IEEE Computer Society Press, Los Alamitos, 1972.
- [MV96] A. A. Muchnik and N. K. Vereshchagin. A general method to construct oracles realizing given relationships between complexity classes. *Theoretical Computer Science*, 157(2):227–258, 1996.
- [NRRS98] A. V. Naik, J. D. Rogers, J. S. Royer, and A. L. Selman. A hierarchy based on output multiplicity. *Theoretical Computer Science*, 207(1):131–157, 1998.
- [Odi99] P. G. Odifreddi. *Classical Recursion Theory, Volume II*. Number 143 in Studies in Logic and the Foundation of Mathematics. North-Holland, Amsterdam, 1999.
- [Ogi96] M. Ogiwara. Functions computable with limited access to NP. *Information Processing Letters*, 58(1):35–38, 1996.
- [PY84] C. H. Papadimitriou and M. Yannakakis. The complexity of facets (and some facets of complexity). *Journal of Computer and System Sciences*, 28(2):244–259, 1984.
- [Raz94] A. A. Razborov. On provably disjoint NP pairs. Technical Report RS-94-36, Basic Research in Computer Science Center, Aarhus, 1994.
- [Raz95] A. A. Razborov. Bounded arithmetic and lower bounds in boolean complexity. In P. Clote and J. B. Remmel, editors, *Feasible Mathematics II*, volume 13 of *Progress in Computer Science and Applied Logic*, pages 344–387. Birkhäuser, Boston, 1995.
- [RW98] S. Reith and K. W. Wagner. On boolean lowness and boolean highness. In *Proceedings 4th Annual International Computing & Combinatorics Conference*, volume 1449 of *Lecture Notes in Computer Science*, pages 147–156. Springer-Verlag, Berlin, 1998.
- [Sch83] U. Schöning. A low and a high hierarchy within NP. *Journal of Computer and System Sciences*, 27:14–28, 1983.
- [Sch88] U. Schöning. Graph isomorphism is in the low hierarchy. *Journal of Computer and System Sciences*, 37(3):312–323, 1988.
- [Sel92] A. L. Selman. A survey of one-way functions in complexity theory. *Mathematical Systems Theory*, 25:203–221, 1992.
- [Sel94a] V. L. Selivanov. Two refinements of the polynomial hierarchy. In *Proceedings 11th Annual Symposium on Theoretical Aspects of Computer Science*, volume 775 of *Lecture Notes in Computer Science*, pages 439–448. Springer-Verlag, Berlin, 1994.

- [Sel94b] A. L. Selman. A taxonomy of complexity classes of functions. *Journal of Computer and System Sciences*, 48:357–381, 1994.
- [Sel95] V. L. Selivanov. Fine hierarchies and boolean terms. *Journal of Symbolic Logic*, 60(1):289–317, 1995.
- [Sel96] A. L. Selman. Much ado about functions. In *Proceedings 11th IEEE Conference on Computational Complexity*, pages 198–212. IEEE Computer Society Press, Los Alamitos, 1996.
- [Sho58] J. R. Shoenfield. Degrees of formal systems. *Journal of Symbolic Logic*, 23:389–392, 1958.
- [SL96] M.-J. Sheu and T. J. Long. UP and the low and high hierarchies: A relativized separation. *Mathematical Systems Theory*, 29:423–449, 1996.
- [SP98] U. Schöning and R. Pruim. *Gems of Theoretical Computer Science*. Springer-Verlag, Berlin, 1998.
- [Sto77] L. Stockmeyer. The polynomial-time hierarchy. *Theoretical Computer Science*, 3:1–22, 1977.
- [Tar49] A. Tarski. On essential undecidability. *Journal of Symbolic Logic*, 14:75–76, 1949.
- [Tra53] B. A. Trakhtenbrot. On recursive separability. *Doklady Akademii Nauk SSSR*, 88:953–956, 1953. In Russian.
- [Usp53] V. A. Uspenski. Gödel’s theorem and the theory of algorithms. *Doklady Akademii Nauk SSSR*, 91:737–740, 1953. In Russian.
- [Ver93] N. K. Vereshchagin. Relativizable and non-relativizable theorems in the polynomial theory of algorithms. *Izvestija Rossijskoj Akademii Nauk*, 57:51–90, 1993. In Russian.
- [Vol99] H. Vollmer. Uniform characterizations of complexity classes. *ACM SIGACT-Newsletter*, 30(1):17–27, 1999.
- [Wag79] K. W. Wagner. On  $\omega$ -regular sets. *Information and Control*, 43:123–177, 1979.
- [Wag87] K. W. Wagner. Number-of-query hierarchies. Technical Report 158, Universität Augsburg, Institut für Informatik, 1987.
- [Wag89] K. W. Wagner. Number-of-query hierarchies. Technical Report 4, Julius-Maximilians-Universität Würzburg, Institut für Informatik, 1989.
- [Wag90] K. W. Wagner. Bounded query classes. *SIAM Journal on Computing*, 19:833–846, 1990.
- [Wag98] K. W. Wagner. A note on parallel queries and the symmetric-difference hierarchy. *Information Processing Letters*, 66(1):13–20, 1998.
- [WW85] K. W. Wagner and G. Wechsung. On the boolean closure of NP. Extended abstract as: G. Wechsung. On the boolean closure of NP. *Proceedings 5th International Conference on Fundamentals in Computation Theory*, volume 199 of *Lecture Notes in Computer Science*, pages 485–493, Berlin, 1985.
- [WW86] K. W. Wagner and G. Wechsung. *Computational Complexity*. Deutscher Verlag der Wissenschaften, Berlin, 1986.
- [Yao85] A. C. C. Yao. Separating the polynomial-time hierarchy by oracles. In *Proceedings 26th Symposium on Foundations of Computer Science*, pages 1–10. IEEE Computer Society Press, Los Alamitos, 1985.

# Index

- $0_G$ , 21
- $1_G$ , 21
- $A^{\leq n}$ , 20
- $A^{\leq n}$ , 20
- $(\mathcal{C}_1, \dots, \mathcal{C}_{k-1}, \cdot)$ , 28
- $\mathcal{C}/\text{poly}$ , 23
- $(G, f, S)$ , 34, 68
- $\mathcal{K}(a)$  (for a word  $a$ ), 45
- $\mathcal{K}(m)$  (for a number  $m$ ), 25
- $\mathcal{K}(f)$  (for a function  $f$ ), 26, 29
- $\mathcal{K}(G, f)$ , 34, 68
- $\mathcal{K}(G, H, f)$ , 71
- $\mu(f)$ , 26
- $\mu(G, f)$ , 40
- $\mu_i(G, f)$ , 76
- $\mu_{\bar{i}}(G, f)$ , 76
- $\mu_{I,J}(G, f)$ , 41
- $\pi_j^m$ , 22
- $\bar{x}$ , 20
- $\partial$ , 20, 21
- $\|\cdot\|$ , 19
- $|\cdot|_a$ , 20
- $\circ$ , 20
- $\langle \cdot, \cdot \rangle$ , 22
- $\Delta$ , 19
- $\wedge$  (meet), 21
- $\vee$  (join), 21
- $\cong$  (for posets), 21
- $\cong$  (for labeled posets), 37
- $\equiv$  (for  $k$ -posets), 35
- $\Vdash$ , 12
- $\hookrightarrow$ , 15, 16
- $\leq$  (for  $k$ -posets), 15, 35
- $\leq_{\text{lex}}$ , 20
- $\leq_m^p$ , 22, 49, 65, 88
- $\preceq$ , 45
- $\in_c$ , 105
- $\subseteq_c$ , 105
  
- INP, 13
  
- antichain, 21
  
- $\mathfrak{B}_r$ , 78
- $\text{BC}(\cdot)$ , 19
- $\text{BC}_k(\cdot)$ , 30
- $\text{BH}_k(\cdot)$ , 30
- boolean characteristic, 80
- boolean hierarchy (of sets), 13, 25
  
- extended, 27
- typed, 27
  
- $c_A$ , 19, 27
- canonical embedding, 45
- C=L, 13
- C=P, 13
- chain, 21
- labeled, 34
- closure
- boolean, 19, 30
- projective, 27, 74
- coNP, 13
- Craig interpolants, 96
  
- $\mathfrak{D}_m$ , 74
- $\Delta_m^p$ , 24
- DP, 13, 14
- descriptive set theory, 95
  
- easy-hard technique, 50, 51
- element
- maximal, 21
- meet-irreducible, 22
- minimal, 21
- Embedding Lemma, 35, 70, 74
- ENTAILMENT, 12, 66, 77, 88
- essential undecidability, 95
  
- $\mathfrak{F}(m, n)$ , 103
- $\mathfrak{F}(m, \infty)$ , 103
- $\mathfrak{F}(\infty, n)$ , 103
- $\mathfrak{F}(\infty, \infty)$ , 103
- FP, 22
- function
- advice, 23
- characteristic, 19, 27
- dual, 20
- monotonic, 21
- multi-valued, 105
- one-way, 95
  
- GRAPH EMBEDDING, 16, 68, 88
- GRAPH ISOMORPHISM, 16
  
- $\mathfrak{H}_m$ , 87
- hard sequence, 50
- maximal, 50, 51
- High $_k$ , 97

- homomorphism, 33, 67, 71
- infimum of a poset, 21
- join, 21
- $k$ -chain, 34
- $k$ -lattice, 34
  - boolean, 34
  - minimal, 37
- $k$ -partition, 27
- $k$ -poset, 34
  - isomorphic, 27
  - minimal, 37
- $k$ -word, 45
  - repetition-free, 45
- lattice, 21
  - boolean, 22
  - labeled, 34
  - labeled boolean, 34
  - minimal labeled, 37
- $\text{Leaf}_k^P(\cdot)$ , 90
- $\text{Low}_k$ , 97
- maximum, 21
- meet, 21
- mind-change technique, 26, 44, 45
- minimum, 21
- $\mathbb{N}_+$ , 19
- $\mathfrak{N}(A)$ , 106
- $\mathfrak{N}(A, B)$ , 106
- narrowing-gap condition, 106
- Narrowing-Gap Conjecture, 106
- $\text{NP}_A V$ , 105
- $\text{NPMV}$ , 105
- $\text{NPSV}$ , 105
- number-of-query hierarchy, 27
- operator
  - $\wedge$ , 19
  - $\vee$ , 19
  - $\oplus$ , 19
  - co, 19
  - $U$ , 97
- ordering
  - lexicographical, 20
  - vector-, 20
- $\mathcal{P}(\cdot)$ , 19
- $P$ , 24
- $P_{\parallel}^{\text{NP}}[m]$  27
- pair
  - $\mathcal{K}$ -separable, 96
  - $m$ -separable, 99
  - weakly  $\mathcal{K}$ -separable, 96
- partition class
  - boundly represented, 27
  - freely represented, 28
- partition of simple counting type, 91
- $\text{PH}$ , 24
- $\Pi_m^p$ , 24
- poly, 23
- polynomial advice, 23
- poset, 21
  - dual, 21
  - isomorphic, 21
  - isomorphic labeled, 37
  - labeled, 34
  - minimal labeled, 37
- projection class, 27
- Projection Theorem, 77
- projectively closed, 28
- proof systems, 96
- $P$ -separability, 96
- $\text{RBH}_k(\cdot)$ , 69
- $\text{RE}$ , 23, 42, 95
- $\text{REC}$ , 23, 95
- reduction
  - $\leq_m^p$ , 22, 49, 65, 88
  - strong nondeterministic, 104
  - witness-isomorphic, 96
- refined boolean hierarchy (of partitions), 69
- refinement, 105
- relation
  - entailment, 12
  - graph-embedding, 15
- representation of a partition class
  - bound, 27
  - free, 28
- $\text{RP}$ , 13
- $\mathfrak{S}_0$ , 96
- $\mathfrak{S}_m$ , 98
- $\mathfrak{S}_\infty$ , 96
- $\mathfrak{S}_m^0$ , 98
- $\mathfrak{S}_\infty^0$ , 98
- $\text{SATISFIABILITY}$ , 23, 55, 66, 97
- set
  - creative, 95
  - $P$ -superterse, 96
  - recursive, 23, 95
  - recursively enumerable, 23, 42, 95
  - selective, 15, 96
  - self-reducible, 23, 96
- $\Sigma_m^p$ , 24
- $\text{SUBGRAPH ISOMORPHISM}$ , 16
- subposet, 21
- supremum of a poset, 21
- $\text{TAUTOLOGY}$ , 23, 97
- Turing machine, 22
  - categorical, 22
  - deterministic, 22
  - nondeterministic, 22
  - oracle, 22
- Turing transducer, 22
- twister, 51
- $\text{UP}$ , 13, 24, 89
- $\text{US}$ , 13
- $\text{ZPP}^{\text{NP}}$ , 105